

# RABOESCH®

RC Model Boat Accessories



2024



**GB** At Raboesch Models we have been, enthusiastically, creating model ship building products for more than 36 years. High-quality products, precise tools and professionalism result in top quality-products. Through a global network of distributors and dealers our products end up in the hands of the hobbyist. Also outside of the model building sector companies discover the high and constant quality of the Raboesch products. Our products are being used, more and more lately, in the high-tech industry, such as in robotics, various research & development departments and government institutions.

In front of you lies the Raboesch catalog with all the new as well as the more trusted classic products. We wish you plenty of enjoyment while perusing our offers and we invite you to allow yourself to be inspired at one of our retail outlets. On our website: [www.raboeschmodels.com](http://www.raboeschmodels.com) you will find an up-to-date overview of all our products and activities.

**NL** Al ruim 36 jaar worden er bij Raboesch Models, met enthousiasme, producten vervaardigd voor de scheepsmodelbouw. Hoogwaardige materialen, precisie gereedschap en vakmanschap resulteren in producten van topkwaliteit. Via een wereldwijd netwerk van distributeurs en dealers komen de producten terecht bij de hobbyist. Ook buiten de modelbouwbranche ontdekken bedrijven de hoge en constante kwaliteit van Raboesch producten. Onze producten worden steeds meer gebruikt in de hightech industrie, zoals in robotica, diverse research & development afdelingen en overheidsinstellingen.

Voor u ligt de Raboesch catalogus met nieuwe en vertrouwde producten. We wensen u veel plezier bij het bekijken van ons aanbod en nodigen u uit om u te laten inspireren bij een van onze verkooppunten. Op onze website: [www.raboeschmodels.com](http://www.raboeschmodels.com) vindt u een actueel overzicht van onze producten en activiteiten.

**DE** Schon seit mehr als 36 Jahren werden bei Raboesch Models, mit Begeisterung Produkte für den Schiffsmodellbau hergestellt. Hochwertige Materialien, Präzisionsgeräte sowie fachmännisches Können erzeugen Produkte in Spitzenqualität. Über ein weltweites Händler- und Verteilernetzwerk gelangen die Produkte beim Hobbyisten. Auch außerhalb der Modellbaubranche entdecken Firmen die hohe und gleichbleibende Qualität der Raboesch Produkte. Unsere Produkte werden immer häufiger in der Hightech Industrie verwendet, zum Beispiel für Robotik-Systeme, in verschiedenen Forschungs- und Entwicklungsabteilungen und bei Behördeninstanzen.

Vor Ihnen liegt jetzt der Raboesch Katalog mit neuen und vertrauten Produkten. Wir wünschen Ihnen viel Freude beim Stöbern durch unser Angebot und laden Sie ein, sich von einer unserer Verkaufsstellen begeistern und inspirieren zu lassen. Auf unserer Website: [www.raboeschmodels.com](http://www.raboeschmodels.com) finden Sie eine aktuelle Übersicht unserer Produkte und Aktivitäten.

**FR** Depuis plus de 36 ans, chez Raboesch Models, avec enthousiasme, on fabrique des produits pour le modélisme naval. Les matériaux de haute qualité, les outils de précision et l'artisanat résultent en des produits de haute qualité. Grâce à un réseau mondial de distributeurs et de revendeurs, les produits arrivent chez les amateurs. Egalement en dehors du secteur d'activité de la construction de maquettes, les entreprises découvrent la qualité élevée et constante des produits Raboesch. Nos produits sont de plus en plus utilisés dans les industries de haute technologie, telles que la robotique, les divers départements de recherche et développement et les organismes gouvernementaux.

Vous avez devant vous le catalogue de Raboesch avec des produits nouveaux et dignes de confiance. Nous vous souhaitons beaucoup de plaisir avec la considération de notre offre et vous invitons à vous laisser inspirer par un de nos points de vente. Sur notre site web: [www.raboeschmodels.com](http://www.raboeschmodels.com) vous trouverez un aperçu de nos produits et de nos activités.

## Rotation direction of propellers

Draairichting van scheepsschroeven – Drehrichtung Schiffsschrauben – Direction hélices

**GB** In the illustration given below you can see the propellers according to International Standard. All Raboesch Models BV propellers are made according to International Standard

**NL** In de onderstaande illustratie ziet u de schroeven afgebeeld volgens de Internationale Standaard. Alle schroeven van Raboesch Models BV worden geleverd volgens de Internationale standaard.

**DE** In der nachstehenden Zeichnung sind die Schrauben abgebildet nach dem Internationalen Standard. Alle Raboesch Models BV Propeller werden nach Internationalem Standard hergestellt.

**FR** Dans l'illustration ci-dessous, vous voyez les hélices représentées pour vous selon la Norme Internationale. Toutes les hélices de Raboesch Models BV sont fabriquées selon la Norme Internationale.

### Rotation direction of Raboesch propellers

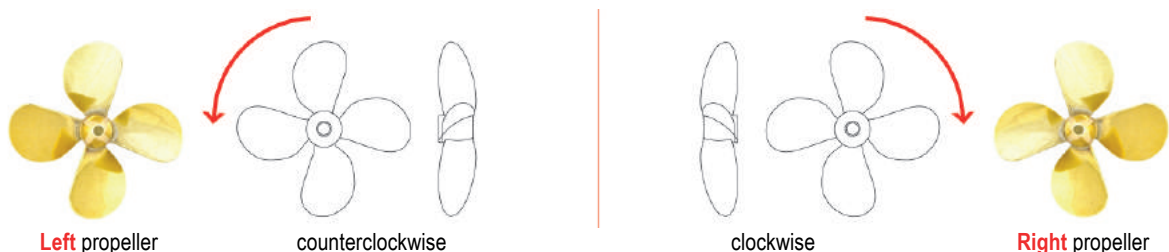

# Brass propellers

Messing sloopsschroeven - Messing Schiffsschrauben - Hélices laiton

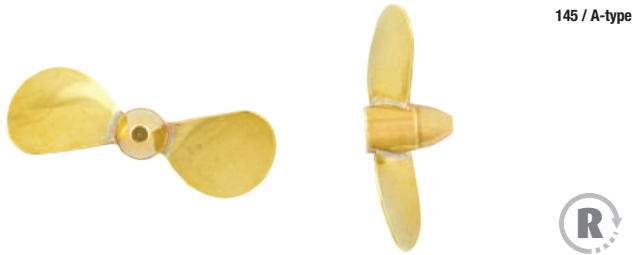

145 / A-type



## 145 - 2 blade METRIC shaft connection

Code	D mm	D inch	R/L	shaft thread	pitch mm	Hub Ø x Length	RPM max.
145-41	20	0,79	R	M2	20,5	6 x 10 mm	16000
145-42	20	0,79	L	M2	20,5	6 x 10 mm	16000
145-43	20	0,79	R	M3	20,5	6 x 10 mm	16000
145-44	20	0,79	L	M3	20,5	6 x 10 mm	16000
145-45	25	0,98	R	M2	25,6	7 x 12 mm	16000
145-46	25	0,98	L	M2	25,6	7 x 12 mm	16000
145-47	25	0,98	R	M3	25,6	7 x 12 mm	16000
145-48	25	0,98	L	M3	25,6	7 x 12 mm	16000
145-49	25	0,98	R	M4	25,6	7 x 12 mm	16000
145-50	25	0,98	L	M4	25,6	7 x 12 mm	16000
145-01	30	1,20	R	M4	30,7	8 x 14,5 mm	14500
145-02	30	1,20	L	M4	30,7	8 x 14,5 mm	14500
145-01A	30	1,20	R	M3	30,7	8 x 14,5 mm	14500
145-02A	30	1,20	L	M3	30,7	8 x 14,5 mm	14500
145-03	35	1,40	R	M4	35,9	8 x 14,5 mm	14500
145-04	35	1,40	L	M4	35,9	8 x 14,5 mm	14500
145-03A	35	1,40	R	M3	35,9	8 x 14,5 mm	14500
145-04A	35	1,40	L	M3	35,9	8 x 14,5 mm	14500
145-05	40	1,60	R	M4	41,0	9 x 16 mm	13000
145-06	40	1,60	L	M4	41,0	9 x 16 mm	13000
145-07	45	1,80	R	M4	46,1	9 x 16 mm	12000
145-08	45	1,80	L	M4	46,1	9 x 16 mm	12000
145-09	50	2,00	R	M4	51,2	10 x 18 mm	10000
145-10	50	2,00	L	M4	51,2	10 x 18 mm	10000
145-11	60	2,40	R	M4	61,5	11 x 22 mm	8000
145-12	60	2,40	L	M4	61,5	11 x 22 mm	8000
145-13	60	2,40	R	M5	61,5	11 x 22 mm	8000
145-14	60	2,40	L	M5	61,5	11 x 22 mm	8000



146 / A-type



## 146 - 3 blade METRIC shaft connection

Code	D mm	D inch	R/L	shaft thread	pitch mm	Hub Ø x Length	RPM max.
146-01	20	0,79	R	M3	20,5	6 x 10 mm	16000
146-02	20	0,79	L	M3	20,5	6 x 10 mm	16000
146-01A	20	0,79	R	M2	20,5	6 x 10 mm	16000
146-02A	20	0,79	L	M2	20,5	6 x 10 mm	16000
146-05	20	0,79	R	M4	20,5	6 x 10 mm	16000
146-06	20	0,79	L	M4	20,5	6 x 10 mm	16000
146-03	25	0,98	R	M3	25,6	7 x 12 mm	16000
146-04	25	0,98	L	M3	25,6	7 x 12 mm	16000
146-03A	25	0,98	R	M2	25,6	7 x 12 mm	16000

## 146 - 3 blade METRIC shaft connection

Code	D mm	D inch	R/L	shaft thread	pitch mm	Hub Ø x Length	RPM max.
146-04A	25	0,98	L	M2	25,6	7 x 12 mm	16000
146-07	25	0,98	R	M4	25,6	7 x 12 mm	16000
146-08	25	0,98	L	M4	25,6	7 x 12 mm	16000
146-09	30	1,20	R	M4	30,7	8 x 14,5 mm	14500
146-10	30	1,20	L	M4	30,7	8 x 14,5 mm	14500
146-09A	30	1,20	R	M3	30,7	8 x 14,5 mm	14500
146-10A	30	1,20	L	M3	30,7	8 x 14,5 mm	14500
146-11	35	1,40	R	M4	35,9	8 x 14,5 mm	14500
146-12	35	1,40	L	M4	35,9	8 x 14,5 mm	14500
146-11A	35	1,40	R	M3	35,9	8 x 14,5 mm	14500
146-12A	35	1,40	L	M3	35,9	8 x 14,5 mm	14500
146-13	40	1,60	R	M4	41,0	9 x 16 mm	13000
146-14	40	1,60	L	M4	41,0	9 x 16 mm	13000
146-15	45	1,80	R	M4	46,1	9 x 16 mm	12000
146-16	45	1,80	L	M4	46,1	9 x 16 mm	12000
146-17	50	2,00	R	M4	51,2	10 x 18 mm	10000
146-18	50	2,00	L	M4	51,2	10 x 18 mm	10000
146-19	55	2,20	R	M4	56,4	10 x 18 mm	9600
146-20	55	2,20	L	M4	56,4	10 x 18 mm	9600
146-21	60	2,40	R	M4	61,5	11 x 22 mm	8000
146-22	60	2,40	L	M4	61,5	11 x 22 mm	8000
146-21A	60	2,40	R	M5	61,5	11 x 22 mm	8000
146-22A	60	2,40	L	M5	61,5	11 x 22 mm	8000
146-23	65	2,60	R	M4	66,6	11 x 22 mm	6600
146-24	65	2,60	L	M4	66,6	11 x 22 mm	6600
146-23A	65	2,60	R	M5	66,6	11 x 22 mm	6600
146-24A	65	2,60	L	M5	66,6	11 x 22 mm	6600
146-25	70	2,80	R	M5	71,7	12 x 24 mm	6200
146-26	70	2,80	L	M5	71,7	12 x 24 mm	6200
146-25A	70	2,80	R	M4	71,7	12 x 24 mm	6200
146-26A	70	2,80	L	M4	71,7	12 x 24 mm	6200
146-27	75	3,00	R	M5	76,9	12 x 24 mm	4200
146-28	75	3,00	L	M5	76,9	12 x 24 mm	4200
146-27A	75	3,00	R	M4	76,9	12 x 24 mm	4200
146-28A	75	3,00	L	M4	76,9	12 x 24 mm	4200
146-29	80	3,20	R	M5	82,0	14 x 26 mm	3500
146-30	80	3,20	L	M5	82,0	14 x 26 mm	3500
146-31	90	3,60	R	M5	92,2	14 x 28 mm	3100
146-32	90	3,60	L	M5	92,2	14 x 28 mm	3100
146-33	100	4,00	R	M5	102,5	15 x 30 mm	2800
146-34	100	4,00	L	M5	102,5	15 x 30 mm	2800
146-35	110	4,40	R	M5	112,8	16 x 32 mm	2500
146-36	110	4,40	L	M5	112,8	16 x 32 mm	2500
146-39	120	4,70	R	M5	123,0	18 x 36 mm	2300
146-40	120	4,70	L	M5	123,0	18 x 36 mm	2300
146-37	130	5,10	R	M5	133,2	20 x 40 mm	2150
146-38	130	5,10	L	M5	133,2	20 x 40 mm	2150



147 / A-type



## 147 - 4 blade METRIC shaft connection

# Brass propellers

Messing sloopsschroeven - Messing Schiffsschrauben - Hélices laiton

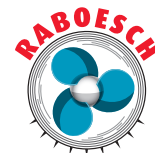

hobby products

## 147 - 4 blade

### METRIC shaft connection

Code	D mm	D inch	R/L	shaft thread	pitch mm	Hub Ø x Length	RPM max.
147-01	20	0,79	R	M3	20,5	6 x 10 mm	16000
147-02	20	0,79	L	M3	20,5	6 x 10 mm	16000
147-01A	20	0,79	R	M2	20,5	6 x 10 mm	16000
147-02A	20	0,79	L	M2	20,5	6 x 10 mm	16000
147-05	20	0,79	R	M4	20,5	6 x 10 mm	16000
147-06	20	0,79	L	M4	20,5	6 x 10 mm	16000
147-03	25	0,98	R	M3	25,6	7 x 12 mm	16000
147-04	25	0,98	L	M3	25,6	7 x 12 mm	16000
147-03A	25	0,98	R	M2	25,6	7 x 12 mm	16000
147-04A	25	0,98	L	M2	25,6	7 x 12 mm	16000
147-07	25	0,98	R	M4	25,6	7 x 12 mm	16000
147-08	25	0,98	L	M4	25,6	7 x 12 mm	16000
147-09	30	1,20	R	M4	30,7	8 x 14,5 mm	14500
147-10	30	1,20	L	M4	30,7	8 x 14,5 mm	14500
147-09A	30	1,20	R	M3	30,7	8 x 14,5 mm	14500
147-10A	30	1,20	L	M3	30,7	8 x 14,5 mm	14500
147-11	35	1,40	R	M4	35,9	8 x 14,5 mm	14500
147-12	35	1,40	L	M4	35,9	8 x 14,5 mm	14500
147-11A	35	1,40	R	M3	35,9	8 x 14,5 mm	14500
147-12A	35	1,40	L	M3	35,9	8 x 14,5 mm	14500
147-13	40	1,60	R	M4	41,0	9 x 16 mm	13000
147-14	40	1,60	L	M4	41,0	9 x 16 mm	13000
147-15	45	1,80	R	M4	46,1	9 x 16 mm	12000
147-16	45	1,80	L	M4	46,1	9 x 16 mm	12000
147-17	50	2,00	R	M4	51,2	10 x 18 mm	10000
147-18	50	2,00	L	M4	51,2	10 x 18 mm	10000
147-19	55	2,20	R	M4	56,4	10 x 18 mm	9600
147-20	55	2,20	L	M4	56,4	10 x 18 mm	9600
147-21	60	2,40	R	M4	61,5	11 x 22 mm	8000
147-22	60	2,40	L	M4	61,5	11 x 22 mm	8000
147-21A	60	2,40	R	M5	61,5	11 x 22 mm	8000
147-22A	60	2,40	L	M5	61,5	11 x 22 mm	8000
147-23	65	2,60	R	M4	66,6	11 x 22 mm	6600
147-24	65	2,60	L	M4	66,6	11 x 22 mm	6600
147-23A	65	2,60	R	M5	66,6	11 x 22 mm	6600
147-24A	65	2,60	L	M5	66,6	11 x 22 mm	6600
147-25	70	2,80	R	M5	71,7	12 x 24 mm	6200
147-26	70	2,80	L	M5	71,7	12 x 24 mm	6200
147-25A	70	2,80	R	M4	71,7	12 x 24 mm	6200
147-26A	70	2,80	L	M4	71,7	12 x 24 mm	6200
147-27	75	3,00	R	M5	76,9	12 x 24 mm	4200
147-28	75	3,00	L	M5	76,9	12 x 24 mm	4200
147-27A	75	3,00	R	M4	76,9	12 x 24 mm	4200
147-28A	75	3,00	L	M4	76,9	12 x 24 mm	4200
147-29	80	3,20	R	M5	82,0	14 x 26 mm	3500
147-30	80	3,20	L	M5	82,0	14 x 26 mm	3500
147-31	90	3,60	R	M5	92,2	14 x 28 mm	3100
147-32	90	3,60	L	M5	92,2	14 x 28 mm	3100
147-33	100	4,00	R	M5	102,5	15 x 30 mm	2800
147-34	100	4,00	L	M5	102,5	15 x 30 mm	2800
147-35	110	4,40	R	M5	112,8	16 x 32 mm	2500
147-36	110	4,40	L	M5	112,8	16 x 32 mm	2500
147-39	120	4,70	R	M5	123,0	18 x 36 mm	2300
147-40	120	4,70	L	M5	123,0	18 x 36 mm	2300
147-37	130	5,10	R	M5	133,2	20 x 40 mm	2150
147-38	130	5,10	L	M5	133,2	20 x 40 mm	2150



148 / A-type



## 148 - 5 blade

### METRIC shaft connection

Code	D mm	D inch	R/L	shaft thread	pitch mm	Hub Ø x Length	RPM max.
148-41	20	0,79	R	M2	20,5	6 x 10 mm	16000
148-42	20	0,79	L	M2	20,5	6 x 10 mm	16000
148-43	20	0,79	R	M3	20,5	6 x 10 mm	16000
148-44	20	0,79	L	M3	20,5	6 x 10 mm	16000
148-45	25	0,98	R	M2	25,6	7 x 12 mm	16000
148-46	25	0,98	L	M2	25,6	7 x 12 mm	16000
148-47	25	0,98	R	M3	25,6	7 x 12 mm	16000
148-48	25	0,98	L	M3	25,6	7 x 12 mm	16000
148-49	25	0,98	R	M4	25,6	7 x 12 mm	16000
148-50	25	0,98	L	M4	25,6	7 x 12 mm	16000
148-01	30	1,20	R	M4	30,7	8 x 14,5 mm	14500
148-02	30	1,20	L	M4	30,7	8 x 14,5 mm	14500
148 01A	30	1,20	R	M3	30,7	8 x 14,5 mm	14500
148-02A	30	1,20	L	M3	30,7	8 x 14,5 mm	14500
148-03	35	1,40	R	M4	35,9	8 x 14,5 mm	14500
148-04	35	1,40	L	M4	35,9	8 x 14,5 mm	14500
148-03A	35	1,40	R	M3	35,9	8 x 14,5 mm	14500
148-04A	35	1,40	L	M3	35,9	8 x 14,5 mm	14500
148-05	40	1,60	R	M4	41,0	9 x 16 mm	13000
148-06	40	1,60	L	M4	41,0	9 x 16 mm	13000
148-07	45	1,80	R	M4	46,1	9 x 16 mm	12000
148-08	45	1,80	L	M4	46,1	9 x 16 mm	12000
148-09	50	2,00	R	M4	51,2	10 x 18 mm	10000
148-10	50	2,00	L	M4	51,2	10 x 18 mm	10000
148-11	55	2,20	R	M4	56,4	10 x 18 mm	9600
148-12	55	2,20	L	M4	56,4	10 x 18 mm	9600
148-13	60	2,40	R	M4	61,5	11 x 22 mm	8000
148-14	60	2,40	L	M4	61,5	11 x 22 mm	8000
148-13A	60	2,40	R	M5	61,5	11 x 22 mm	8000
148-14A	60	2,40	L	M5	61,5	11 x 22 mm	8000
148-15	65	2,60	R	M4	66,6	11 x 22 mm	6600
148-16	65	2,60	L	M4	66,6	11 x 22 mm	6600
148-15A	65	2,60	R	M5	66,6	11 x 22 mm	6600
148-16A	65	2,60	L	M5	66,6	11 x 22 mm	6600
148-17	70	2,80	R	M4	71,7	12 x 24 mm	6200
148-18	70	2,80	L	M4	71,7	12 x 24 mm	6200
148-17A	70	2,80	R	M5	71,7	12 x 24 mm	6200
148-18A	70	2,80	L	M5	71,7	12 x 24 mm	6200
148-19	75	3,00	R	M5	76,9	12 x 24 mm	4200
148-20	75	3,00	L	M5	76,9	12 x 24 mm	4200
148-21	80	3,20	R	M5	82,0	14 x 26 mm	3500
148-22	80	3,20	L	M5	82,0	14 x 26 mm	3500
148-23	90	3,60	R	M5	92,2	14 x 28 mm	3100
148-24	90	3,60	L	M5	92,2	14 x 28 mm	3100
148-25	100	4,00	R	M5	102,5	15 x 30 mm	2800
148-26	100	4,00	L	M5	102,5	15 x 30 mm	2800
148-27	110	4,40	R	M5	112,8	16 x 32 mm	2500
148-28	110	4,40	L	M5	112,8	16 x 32 mm	2500
148-29	120	4,70	R	M5	123,0	18 x 36 mm	2300
148-30	120	4,70	L	M5	123,0	18 x 36 mm	2300
148-31	130	5,10	R	M5	133,2	20 x 40 mm	2150
148-32	130	5,10	L	M5	133,2	20 x 40 mm	2150

# Brass propellers

Messing sloopsschroeven - Messing Schiffsschrauben - Hélices laiton



149 / A-type



## 149 - 4 blade

## METRIC shaft connection

Code	D mm	D inch	R/L	shaft thread	pitch mm	Hub Ø x Length	RPM max.
149-01	30	1,20	R	M4	30,7	8 x 14,5 mm	14500
149-02	30	1,20	L	M4	30,7	8 x 14,5 mm	14500
149-01A	30	1,20	R	M3	30,7	8 x 14,5 mm	14500
149-02A	30	1,20	L	M3	30,7	8 x 14,5 mm	14500
149-03	35	1,40	R	M4	35,9	9 x 16 mm	14500
149-04	35	1,40	L	M4	35,9	9 x 16 mm	14500
149-05	40	1,60	R	M4	41,0	10 x 18 mm	13000
149-06	40	1,60	L	M4	41,0	10 x 18 mm	13000
149-07	45	1,80	R	M4	46,1	10 x 18 mm	12000
149-08	45	1,80	L	M4	46,1	10 x 18 mm	12000
149-09	50	2,00	R	M4	51,2	11 x 22 mm	10000
149-10	50	2,00	L	M4	51,2	11 x 22 mm	10000
149-65	55	2,20	R	M4	56,4	11 x 22 mm	9600
149-66	55	2,20	L	M4	56,4	11 x 22 mm	9600
149-67	55	2,20	R	M5	56,4	11 x 22 mm	9600
149-68	55	2,20	L	M5	56,4	11 x 22 mm	9600
149-11	60	2,40	R	M5	61,5	12 x 24 mm	8000
149-12	60	2,40	L	M5	61,5	14 x 24 mm	8000
149-11A	60	2,40	R	M4	61,5	14 x 24 mm	8000
149-12A	60	2,40	L	M4	61,5	15 x 24 mm	8000
149-13	70	2,80	R	M5	71,7	13 x 26 mm	6200
149-14	70	2,80	L	M5	71,7	13 x 26 mm	6200
149-15	80	3,20	R	M5	82,0	15 x 30 mm	3500
149-16	80	3,20	L	M5	82,0	15 x 30 mm	3500
149-17	90	3,60	R	M5	92,2	16 x 32 mm	3100
149-18	90	3,60	L	M5	92,2	16 x 32 mm	3100
149-19	100	4,00	R	M5	102,5	18 x 36 mm	2800
149-20	100	4,00	L	M5	102,5	18 x 36 mm	2800
149-21	110	4,40	R	M5	112,8	20 x 40 mm	2500
149-22	110	4,40	L	M5	112,8	20 x 40 mm	2500



150 / A-type



## 150 - 3 blade

## METRIC shaft connection

Code	D mm	D inch	R/L	shaft thread	pitch mm	Hub Ø x Length	RPM max.
150-01	30	1,20	R	M3	30,7	8 x 14,5 mm	14500
150-02	30	1,20	L	M3	30,7	8 x 14,5 mm	14500
150-03	30	1,20	R	M4	30,7	8 x 14,5 mm	14500
150-04	30	1,20	L	M4	30,7	8 x 14,5 mm	14500
150-05	35	1,40	R	M4	35,9	9 x 16 mm	14500
150-06	35	1,40	L	M4	35,9	9 x 16 mm	14500
150-07	40	1,60	R	M4	41,0	10 x 18 mm	13000
150-08	40	1,60	L	M4	41,0	10 x 18 mm	13000
150-09	45	1,80	R	M4	46,1	10 x 18 mm	12000

Code	D mm	D inch	R/L	shaft thread	pitch mm	Hub Ø x Length	RPM max.
150-10	45	1,80	L	M4	46,1	10 x 18 mm	12000
150-11	50	2,00	R	M4	51,2	11 x 22 mm	10000
150-12	50	2,00	L	M4	51,2	11 x 22 mm	10000
150-65	55	2,20	R	M4	56,4	11 x 22 mm	9600
150-66	55	2,20	L	M4	56,4	11 x 22 mm	9600
150-67	55	2,20	R	M5	56,4	11 x 22 mm	9600
150-68	55	2,20	L	M5	56,4	11 x 22 mm	9600
150-13	60	2,40	R	M4	61,5	12 x 24 mm	8000
150-14	60	2,40	L	M4	61,5	12 x 24 mm	8000
150-15	60	2,40	R	M5	61,5	12 x 24 mm	8000
150-16	60	2,40	L	M5	61,5	12 x 24 mm	8000
150-17	70	2,80	R	M5	71,7	14 x 26 mm	6200
150-18	70	2,80	L	M5	71,7	14 x 26 mm	6200
150-19	80	3,20	R	M5	82,0	15 x 30 mm	3500
150-20	80	3,20	L	M5	82,0	15 x 30 mm	3500
150-21	90	3,60	R	M5	92,2	16 x 32 mm	3100
150-22	90	3,60	L	M5	92,2	16 x 32 mm	3100
150-23	100	4,00	R	M5	102,5	18 x 36 mm	2800
150-24	100	4,00	L	M5	102,5	18 x 36 mm	2800
150-25	110	4,40	R	M5	112,8	20 x 40 mm	2500
150-26	110	4,40	L	M5	112,8	20 x 40 mm	2500

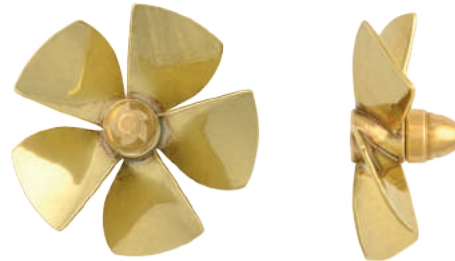

151 / A-type



## 151 - 5 blade

## METRIC shaft connection

Code	D mm	D inch	R/L	shaft thread	pitch mm	Hub Ø x Length	RPM max.
151-01	30	1,20	R	M3	30,7	8 x 14,5 mm	14500
151-02	30	1,20	L	M3	30,7	8 x 14,5 mm	14500
151-03	30	1,20	R	M4	30,7	8 x 14,5 mm	14500
151-04	30	1,20	L	M4	30,7	8 x 14,5 mm	14500
151-05	35	1,40	R	M4	35,9	9 x 16 mm	14500
151-06	35	1,40	L	M4	35,9	9 x 16 mm	14500
151-07	40	1,60	R	M4	41,0	10 x 18 mm	13000
151-08	40	1,60	L	M4	41,0	10 x 18 mm	13000
151-09	45	1,80	R	M4	46,1	10 x 18 mm	12000
151-10	45	1,80	L	M4	46,1	10 x 18 mm	12000
151-11	50	2,00	R	M4	51,2	11 x 22 mm	10000
151-12	50	2,00	L	M4	51,2	11 x 22 mm	10000
151-65	55	2,20	R	M4	56,4	11 x 22 mm	9600
151-66	55	2,20	L	M4	56,4	11 x 22 mm	9600
151-67	55	2,20	R	M5	56,4	11 x 22 mm	9600
151-68	55	2,20	L	M5	56,4	11 x 22 mm	9600
151-13	60	2,40	R	M4	61,5	12 x 24 mm	8000
151-14	60	2,40	L	M4	61,5	12 x 24 mm	8000
151-15	60	2,40	R	M5	61,5	12 x 24 mm	8000
151-16	60	2,40	L	M5	61,5	12 x 24 mm	8000
151-17	70	2,80	R	M5	71,7	14 x 26 mm	6200
151-18	70	2,80	L	M5	71,7	14 x 26 mm	6200
151-19	80	3,20	R	M5	82,0	15 x 30 mm	3500
151-20	80	3,20	L	M5	82,0	15 x 30 mm	3500
151-21	90	3,60	R	M5	92,2	16 x 32 mm	3100
151-22	90	3,60	L	M5	92,2	16 x 32 mm	3100
151-23	100	4,00	R	M5	102,5	18 x 36 mm	2800
151-24	100	4,00	L	M5	102,5	18 x 36 mm	2800
151-25	110	4,40	R	M5	112,8	20 x 40 mm	2500
151-26	110	4,40	L	M5	112,8	20 x 40 mm	2500

# Brass propellers

Messing sloopsschroeven - Messing Schiffsschrauben - Hélices laiton



154 / C-type



## 154 - 2 blade

## METRIC shaft connection

Code	D mm	D inch	R/L	shaft thread	pitch mm	Hub Ø x Length	RPM max.
154-41	20	0,79	R	M2	20,5	6 x 10 mm	16000
154-42	20	0,79	L	M2	20,5	6 x 10 mm	16000
154-43	20	0,79	R	M3	20,5	6 x 10 mm	16000
154-44	20	0,79	L	M3	20,5	6 x 10 mm	16000
154-45	25	0,98	R	M2	25,6	7 x 12 mm	16000
154-46	25	0,98	L	M2	25,6	7 x 12 mm	16000
154-47	25	0,98	R	M3	25,6	7 x 12 mm	16000
154-48	25	0,98	L	M3	25,6	7 x 12 mm	16000
154-49	25	0,98	R	M4	25,6	7 x 12 mm	16000
154-50	25	0,98	L	M4	25,6	7 x 12 mm	16000
154-01	30	1,20	R	M3	26,7	8 x 14,5 mm	14500
154-02	30	1,20	L	M3	26,7	8 x 14,5 mm	14500
154-01A	30	1,20	R	M4	26,7	8 x 14,5 mm	14500
154-02A	30	1,20	L	M4	26,7	8 x 14,5 mm	14500
154-03	35	1,40	R	M3	31,1	8 x 14,5 mm	14500
154-04	35	1,40	L	M3	31,1	8 x 14,5 mm	14500
154-03A	35	1,40	R	M4	31,1	8 x 14,5 mm	14500
154-04A	35	1,40	L	M4	31,1	8 x 14,5 mm	14500
154-05	40	1,60	R	M4	35,6	9 x 16 mm	13000
154-06	40	1,60	L	M4	35,6	9 x 16 mm	13000
154-07	45	1,80	R	M4	40,0	9 x 16 mm	12000
154-08	45	1,80	L	M4	40,0	9 x 16 mm	12000
154-09	50	2,00	R	M4	44,5	10 x 18 mm	10000
154-10	50	2,00	L	M4	44,5	10 x 18 mm	10000
154-11	55	2,20	R	M4	49,0	10 x 18 mm	9600
154-12	55	2,20	L	M4	49,0	10 x 18 mm	9600
154-13	60	2,40	R	M4	61,5	11 x 22 mm	8000
154-14	60	2,40	L	M4	61,5	11 x 22 mm	8000
154-15	60	2,40	R	M5	61,5	11 x 22 mm	8000
154-16	60	2,40	L	M5	61,5	11 x 22 mm	8000



156 / D-type



## 156 - 3 blade

## METRIC shaft connection

Code	D mm	D inch	R/L	shaft thread	pitch mm	Hub Ø x Length	RPM max.
156-41	20	0,79	R	M2	20,5	6 x 10 mm	16000
156-42	20	0,79	L	M2	20,5	6 x 10 mm	16000
156-43	20	0,79	R	M3	20,5	6 x 10 mm	16000
156-44	20	0,79	L	M3	20,5	6 x 10 mm	16000

## 156 - 3 blade

## METRIC shaft connection

Code	D mm	D inch	R/L	shaft thread	pitch mm	Hub Ø x Length	RPM max.
156-45	25	0,98	R	M2	25,6	7 x 12 mm	16000
156-46	25	0,98	L	M2	25,6	7 x 12 mm	16000
156-47	25	0,98	R	M3	25,6	7 x 12 mm	16000
156-48	25	0,98	L	M3	25,6	7 x 12 mm	16000
156-49	25	0,98	R	M4	25,6	7 x 12 mm	16000
156-50	25	0,98	L	M4	25,6	7 x 12 mm	16000
156-01	30	1,20	R	M4	26,7	8 x 14,5 mm	14500
156-02	30	1,20	L	M4	26,7	8 x 14,5 mm	14500
156-01A	30	1,20	R	M3	26,7	8 x 14,5 mm	14500
156-02A	30	1,20	L	M3	26,7	8 x 14,5 mm	14500
156-03	35	1,40	R	M4	31,1	8 x 14,5 mm	14500
156-04	35	1,40	L	M4	31,1	8 x 14,5 mm	14500
156-03A	35	1,40	R	M3	33,1	8 x 14,5 mm	14500
156-04A	35	1,40	L	M3	33,1	8 x 14,5 mm	14500
156-05	40	1,60	R	M4	35,6	9 x 16 mm	13000
156-06	40	1,60	L	M4	35,6	9 x 16 mm	13000
156-07	45	1,80	R	M4	40,0	9 x 16 mm	12000
156-08	45	1,80	L	M4	40,0	9 x 16 mm	12000
156-09	50	2,00	R	M4	44,5	10 x 18 mm	10000
156-10	50	2,00	L	M4	44,5	10 x 18 mm	10000
156-11	55	2,20	R	M4	49,0	10 x 18 mm	9600
156-12	55	2,20	L	M4	49,0	10 x 18 mm	9600
156-13	60	2,40	R	M4	53,3	11 x 22 mm	8000
156-14	60	2,40	L	M4	53,3	11 x 22 mm	8000
156-15	60	2,40	R	M5	53,3	11 x 22 mm	8000
156-16	60	2,40	L	M5	53,3	11 x 22 mm	8000

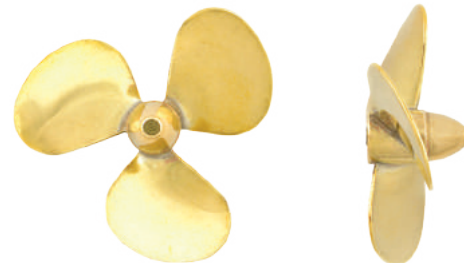

157 / D-type



## 157 - 3 blade

## INCH shaft connection

Code	D mm	D inch	R/L	shaft thread	pitch mm	Hub Ø x Length	RPM max.
157-01	30	1,20	R	3/16	26,7	8 x 14,5 mm	14500
157-02	30	1,20	L	3/16	26,7	8 x 14,5 mm	14500
157-03	35	1,40	R	3/16	31,1	8 x 14,5 mm	14500
157-04	35	1,40	L	3/16	31,1	8 x 14,5 mm	14500
157-05	40	1,60	R	3/16	35,6	9 x 16 mm	13000
157-06	40	1,60	L	3/16	35,6	9 x 16 mm	13000
157-07	45	1,80	R	3/16	40,0	9 x 16 mm	12000
157-08	45	1,80	L	3/16	40,0	9 x 16 mm	12000
157-09	50	2,00	R	3/16	44,5	10 x 18 mm	10000
157-10	50	2,00	L	3/16	44,5	10 x 18 mm	10000
157-11	55	2,20	R	3/16	49,0	10 x 18 mm	9600
157-12	55	2,20	L	3/16	49,0	10 x 18 mm	9600
157-13	60	2,40	R	3/16	53,3	11 x 22 mm	8000
157-14	60	2,40	L	3/16	53,3	11 x 22 mm	8000

# Brass propellers

Messing sloopsschroeven - Messing Schiffsschrauben - Hélices laiton



158 / B-type



## 158 - 4 blade METRIC shaft connection

Code	D mm	D inch	R/L	shaft thread	pitch mm	Hub Ø x Length	RPM max.
158-05	40	1,60	R	M4	41,0	9 x 16 mm	13000
158-06	40	1,60	L	M4	41,0	9 x 16 mm	13000
158-07	45	1,80	R	M4	46,1	9 x 16 mm	12000
158-08	45	1,80	L	M4	46,1	9 x 16 mm	12000
158-09	50	2,00	R	M4	51,2	10 x 18 mm	10000
158-10	50	2,00	L	M4	51,2	10 x 18 mm	10000
158-11	55	2,20	R	M4	56,4	10 x 18 mm	9600
158-12	55	2,20	L	M4	56,4	10 x 18 mm	9600
158-13	60	2,40	R	M4	61,5	11 x 22 mm	8000
158-14	60	2,40	L	M4	61,5	11 x 22 mm	8000
158-13A	60	2,40	R	M5	61,5	11 x 22 mm	8000
158-14A	60	2,40	L	M5	61,5	11 x 22 mm	8000
158-15	65	2,60	R	M4	66,6	11 x 22 mm	6600
158-16	65	2,60	L	M4	66,6	11 x 22 mm	6600
158-15A	65	2,60	R	M5	66,6	11 x 22 mm	6600
158-16A	65	2,60	L	M5	66,6	11 x 22 mm	6600
158-17	70	2,80	R	M4	71,7	12 x 24 mm	6200
158-18	70	2,80	L	M4	71,7	12 x 24 mm	6200
158-17A	70	2,80	R	M5	71,7	12 x 24 mm	6200
158-18A	70	2,80	L	M5	71,7	12 x 24 mm	6200

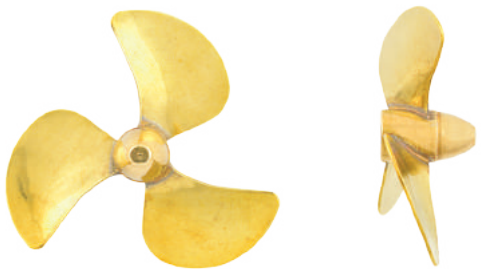

160 / C-type



## 160 - 3 blade METRIC shaft connection

Code	D mm	D inch	R/L	shaft thread	pitch mm	Hub Ø x Length	RPM max.
160-41	20	0,79	R	M2	20,5	5 x 9	16000
160-42	20	0,79	L	M2	20,5	5 x 9	16000
160-43	20	0,79	R	M3	20,5	5 x 9	16000
160-44	20	0,79	L	M3	20,5	5 x 9	16000
160-45	25	0,98	R	M2	25,6	7 x 12 mm	16000
160-46	25	0,98	L	M2	25,6	7 x 12 mm	16000
160-47	25	0,98	R	M3	25,6	7 x 12 mm	16000
160-48	25	0,98	L	M3	25,6	7 x 12 mm	16000
160-49	25	0,98	R	M4	25,6	7 x 12 mm	16000
160-50	25	0,98	L	M4	25,6	7 x 12 mm	16000
160-01	30	1,20	R	M4	26,7	8 x 14,5 mm	14500
160-02	30	1,20	L	M4	26,7	8 x 14,5 mm	14500
160-01A	30	1,20	R	M3	26,7	8 x 14,5 mm	14500
160-02A	30	1,20	L	M3	26,7	8 x 14,5 mm	14500

## 160 - 3 blade METRIC shaft connection

Code	D mm	D inch	R/L	shaft thread	pitch mm	Hub Ø x Length	RPM max.
160-03	35	1,40	R	M4	31,1	8 x 14,5 mm	14500
160-04	35	1,40	L	M4	31,1	8 x 14,5 mm	14500
106-03A	35	1,40	R	M3	31,1	8 x 14,5 mm	14500
160-04A	35	1,40	L	M3	31,1	8 x 14,5 mm	14500
160-05	40	1,60	R	M4	35,6	9 x 16 mm	13000
160-06	40	1,60	L	M4	35,6	9 x 16 mm	13000
160-07	45	1,80	R	M4	40,0	9 x 16 mm	12000
160-08	45	1,80	L	M4	40,0	9 x 16 mm	12000
160-09	50	2,00	R	M4	44,5	10 x 18 mm	10000
160-10	50	2,00	L	M4	44,5	10 x 18 mm	10000
160-11	55	2,20	R	M4	49,0	10 x 18 mm	9600
160-12	55	2,20	L	M4	49,0	10 x 18 mm	9600
160-13	60	2,40	R	M4	53,3	11 x 22 mm	8000
160-14	60	2,40	L	M4	53,3	11 x 22 mm	8000
160-15	60	2,40	R	M5	53,3	11 x 22 mm	8000
160-16	60	2,40	L	M5	53,3	11 x 22 mm	8000

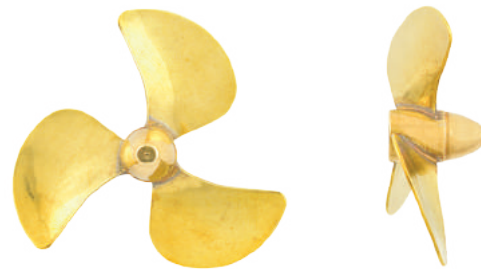

161 / C-type



## 161 - 3 blade INCH shaft connection

Code	D mm	D inch	R/L	shaft thread	pitch mm	Hub Ø x Length	RPM max.
161-05	40	1,60	R	3/16	35,6	9 x 16 mm	13000
161-06	40	1,60	L	3/16	35,6	9 x 16 mm	13000
161-07	45	1,80	R	3/16	40,0	9 x 16 mm	12000
161-08	45	1,80	L	3/16	40,0	9 x 16 mm	12000
161-09	50	2,00	R	3/16	44,5	10 x 18 mm	10000
161-10	50	2,00	L	3/16	44,5	10 x 18 mm	10000

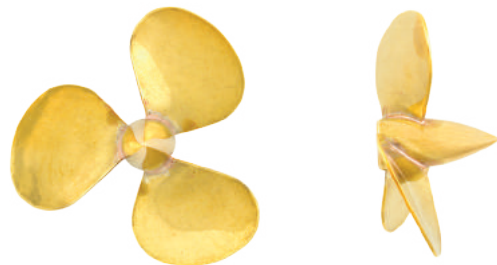

162 / D-type



## 162 - 3 blade METRIC shaft connection

Code	D mm	D inch	R/L	shaft thread	pitch mm	Hub Ø x Length	RPM max.
162-01	20	0,79	R	M2	20,5	6 x 15 mm	16000
162-02	20	0,79	L	M2	20,5	6 x 15 mm	16000
162-03	20	0,79	R	M3	20,5	6 x 15 mm	16000
162-04	20	0,79	L	M3	20,5	6 x 15 mm	16000
162-05	20	0,79	R	M4	20,5	6 x 15 mm	16000
162-06	20	0,79	L	M4	20,5	6 x 15 mm	16000



# Brass propellers

Messing sloopsschroeven - Messing Schiffsschrauben - Hélices laiton

## 162 - 3 blade

### METRIC shaft connection

Code	D mm	D inch	R/L	shaft thread	pitch mm	Hub Ø x Length	RPM max.
162-41	23,5	0,93	R	M2	22,8	6 x 15 mm	16000
162-42	23,5	0,93	L	M2	22,8	6 x 15 mm	16000
162-43	23,5	0,93	R	M3	22,8	6 x 15 mm	16000
162-44	23,5	0,93	L	M3	22,8	6 x 15 mm	16000
162-07	25	0,98	R	M2	25,6	7 x 16 mm	16000
162-08	25	0,98	L	M2	25,6	7 x 16 mm	16000
162-09	25	0,98	R	M3	25,6	7 x 16 mm	16000
162-10	25	0,98	L	M3	25,6	7 x 16 mm	16000
162-11	25	0,98	R	M4	25,6	7 x 16 mm	16000
162-12	25	0,98	L	M4	25,6	7 x 16 mm	16000
162-13	30	1,20	R	M4	26,7	8 x 20 mm	14500
162-14	30	1,20	L	M4	26,7	8 x 20 mm	14500
162-13A	30	1,20	R	M3	26,7	8 x 20 mm	14500
162-14A	30	1,20	L	M3	26,7	8 x 20 mm	14500
162-15	35	1,40	R	M4	31,1	8 x 20 mm	14500
162-16	35	1,40	L	M4	31,1	8 x 20 mm	14500
162-17	40	1,60	R	M4	35,6	9x 21,5 mm	13000
162-18	40	1,60	L	M4	35,6	9x 21,5 mm	13000
162-19	45	1,80	R	M4	40,0	9x 21,5 mm	12000
162-20	45	1,80	L	M4	40,0	9x 21,5 mm	12000
162-21	50	2,00	R	M4	44,5	10 x 23 mm	10000
162-22	50	2,00	L	M4	44,5	10 x 23 mm	10000
162-23	55	2,20	R	M4	49,0	10 x 23 mm	9600
162-24	55	2,20	L	M4	49,0	10 x 23 mm	9600

## 163 - 6 blade

### METRIC shaft connection

Code	D mm	D inch	R/L	shaft thread	pitch mm	Hub Ø x Length	RPM max.
163-21	50	2,00	R	M4	44,5	9 x 16 mm	10000
163-22	50	2,00	L	M4	44,5	9 x 16 mm	10000
163-23	55	2,20	R	M4	49,0	9 x 16 mm	9600
163-24	55	2,20	L	M4	49,0	9 x 16 mm	9600
163-25	60	2,40	R	M4	53,3	10 x 18 mm	8000
163-26	60	2,40	L	M4	53,3	10 x 18 mm	8000
163-27	60	2,40	R	M5	53,3	10 x 18 mm	8000
163-28	60	2,40	L	M5	53,3	10 x 18 mm	8000



163 / D-type



## 164 - 6 blade

### METRIC shaft connection

Code	D mm	D inch	R/L	shaft thread	pitch mm	Hub Ø x Length	RPM max.
164-01	20	0,79	R	M2	20,5	5 x 13 mm	16000
164-02	20	0,79	L	M2	20,5	5 x 13 mm	16000
164-03	20	0,79	R	M3	20,5	5 x 13 mm	16000
164-04	20	0,79	L	M3	20,5	5 x 13 mm	16000
164-05	25	0,98	R	M2	25,6	6 x 15 mm	16000
164-06	25	0,98	L	M2	25,6	6 x 15 mm	16000
164-07	25	0,98	R	M3	25,6	6 x 15 mm	16000
164-08	25	0,98	L	M3	25,6	6 x 15 mm	16000
164-09	25	0,98	R	M4	25,6	6 x 15 mm	16000
164-10	25	0,98	L	M4	25,6	6 x 15 mm	16000
164-11	30	1,20	R	M3	26,7	7 x 16 mm	14500
164-12	30	1,20	L	M3	26,7	7 x 16 mm	14500
164-13	30	1,20	R	M4	26,7	7 x 16 mm	14500
164-14	30	1,20	L	M4	26,7	7 x 16 mm	14500
164-15	35	1,40	R	M4	31,1	7 x 16 mm	14500
164-16	35	1,40	L	M4	31,1	7 x 16 mm	14500
164-17	40	1,60	R	M4	35,6	8 x 20 mm	13000
164-18	40	1,60	L	M4	35,6	8 x 20 mm	13000
164-19	45	1,80	R	M4	40,0	8 x 20 mm	12000
164-20	45	1,80	L	M4	40,0	8 x 20 mm	12000
164-21	50	2,00	R	M4	44,5	9x 21,5 mm	10000
164-22	50	2,00	L	M4	44,5	9x 21,5 mm	10000
164-23	55	2,20	R	M4	49,0	9x 21,5 mm	9600
164-24	55	2,20	L	M4	49,0	9x 21,5 mm	9600
164-25	60	2,40	R	M4	53,3	10 x 23 mm	8000
164-26	60	2,40	L	M4	53,3	10 x 23 mm	8000
164-27	60	2,40	R	M5	53,3	10 x 23 mm	8000
164-28	60	2,40	L	M5	53,3	10 x 23 mm	8000



163 / D-type



## 163 - 6 blade

### METRIC shaft connection

Code	D mm	D inch	R/L	shaft thread	pitch mm	Hub Ø x Length	RPM max.
163-01	20	0,79	R	M2	20,5	5 x 9 mm	16000
163-02	20	0,79	L	M2	20,5	5 x 9 mm	16000
163-03	20	0,79	R	M3	20,5	5 x 9 mm	16000
163-04	20	0,79	L	M3	20,5	5 x 9 mm	16000
163-05	25	0,98	R	M2	25,6	6 x 10 mm	16000
163-06	25	0,98	L	M2	25,6	6 x 10 mm	16000
163-07	25	0,98	R	M3	25,6	6 x 10 mm	16000
163-08	25	0,98	L	M3	25,6	6 x 10 mm	16000
163-09	25	0,98	R	M4	25,6	6 x 10 mm	16000
163-10	25	0,98	L	M4	25,6	6 x 10 mm	16000
163-11	30	1,20	R	M3	26,7	7 x 12 mm	14500
163-12	30	1,20	L	M3	26,7	7 x 12 mm	14500
163-13	30	1,20	R	M4	26,7	7 x 12 mm	14500
163-14	30	1,20	L	M4	26,7	7 x 12 mm	14500
163-15	35	1,40	R	M4	31,1	7 x 12 mm	14500
163-16	35	1,40	L	M4	31,1	7 x 12 mm	14500
163-17	40	1,60	R	M4	35,6	8 x 14,5 mm	13000
163-18	40	1,60	L	M4	35,6	8 x 14,5 mm	13000
163-19	45	1,80	R	M4	40,0	8 x 14,5 mm	12000
163-20	45	1,80	L	M4	40,0	8 x 14,5 mm	12000

# Brass propellers

Messing sloopsschroeven - Messing Schiffsschrauben - Hélices laiton



168 / C-type



## 168 - 5 blade

## METRIC shaft connection

Code	D mm	D inch	R/L	shaft thread	pitch mm	Hub Ø x Length	RPM max.
168-01	20	0,79	R	M2	20,5	6 x 15 mm	16000
168-02	20	0,79	L	M2	20,5	6 x 15 mm	16000
168-03	20	0,79	R	M3	20,5	6 x 15 mm	16000
168-04	20	0,79	L	M3	20,5	6 x 15 mm	16000
168-05	20	0,79	R	M4	20,5	6 x 15 mm	16000
168-06	20	0,79	L	M4	20,5	6 x 15 mm	16000
168-07	25	0,98	R	M3	25,6	7 x 16 mm	16000
168-08	25	0,98	L	M3	25,6	7 x 16 mm	16000
168-09	25	0,98	R	M4	25,6	7 x 16 mm	16000
168-10	25	0,98	L	M4	25,6	7 x 16 mm	16000
168-11	30	1,20	R	M4	26,7	8 x 20 mm	14500
168-12	30	1,20	L	M4	26,7	8 x 20 mm	14500
168-11A	30	1,20	R	M3	26,7	8 x 20 mm	14500
168-12A	30	1,20	L	M3	26,7	8 x 20 mm	14500
168-13	35	1,40	R	M4	31,1	8 x 20 mm	14500
168-14	35	1,40	L	M4	31,1	8 x 20 mm	14500
168-13A	35	1,40	R	M3	32,1	8 x 20 mm	14500
168-14A	35	1,40	L	M3	32,1	8 x 20 mm	14500
168-15	40	1,60	R	M4	35,6	9 x 21,5 mm	13000
168-16	40	1,60	L	M4	35,6	9 x 21,5 mm	13000
168-17	45	1,80	R	M4	40,0	9 x 21,5 mm	12000
168-18	45	1,80	L	M4	40,0	9 x 21,5 mm	12000
168-19	50	2,00	R	M4	44,5	10 x 23 mm	10000
168-20	50	2,00	L	M4	44,5	10 x 23 mm	10000
168-21	55	2,20	R	M4	49,0	10 x 23 mm	9600
168-22	55	2,20	L	M4	49,0	10 x 23 mm	9600



170 / C-type



## 170 - 4 blade

## METRIC shaft connection

Code	D mm	D inch	R/L	shaft thread	pitch mm	Hub Ø x Length	RPM max.
170-41	20	0,79	R	M2	20,5	5 x 9 mm	16000
170-42	20	0,79	L	M2	20,5	5 x 9 mm	16000
170-43	20	0,79	R	M3	20,5	5 x 9 mm	16000
170-44	20	0,79	L	M3	20,5	5 x 9 mm	16000
170-45	25	0,98	R	M2	25,6	7 x 12 mm	16000
170-46	25	0,98	L	M2	25,6	7 x 12 mm	16000
170-01	25	0,98	R	M3	25,6	7 x 12 mm	16000
170-02	25	0,98	L	M3	25,6	7 x 12 mm	16000

## 170 - 4 blade

## METRIC shaft connection

Code	D mm	D inch	R/L	shaft thread	pitch mm	Hub Ø x Length	RPM max.
170-01A	25	0,98	R	M4	25,6	7 x 12 mm	16000
170-02A	25	0,98	L	M4	25,6	7 x 12 mm	16000
170-47	30	1,20	R	M3	26,7	8 x 14,5 mm	14500
170-48	30	1,20	L	M3	26,7	8 x 14,5 mm	14500
170-03	30	1,20	R	M4	26,7	8 x 14,5 mm	14500
170-04	30	1,20	L	M4	26,7	8 x 14,5 mm	14500
170-49	35	1,40	R	M3	31,1	8 x 14,5 mm	14500
170-50	35	1,40	L	M3	31,1	8 x 14,5 mm	14500
170-03A	35	1,40	R	M4	31,1	8 x 14,5 mm	14500
170-04A	35	1,40	L	M4	31,1	8 x 14,5 mm	14500
170-05	40	1,60	R	M4	35,6	9 x 16 mm	13000
170-06	40	1,60	L	M4	35,6	9 x 16 mm	13000
170-07	45	1,80	R	M4	40,0	9 x 16 mm	12000
170-08	45	1,80	L	M4	40,0	9 x 16 mm	12000
170-09	50	2,00	R	M4	44,5	10 x 18 mm	10000
170-10	50	2,00	L	M4	44,5	10 x 18 mm	10000
170-11	55	2,20	R	M4	49,0	10 x 18 mm	9600
170-12	55	2,20	L	M4	49,0	10 x 18 mm	9600
170-13	60	2,40	R	M4	53,3	11 x 22 mm	8000
170-14	60	2,40	L	M4	53,3	11 x 22 mm	8000
170-13A	60	2,40	R	M5	53,3	11 x 22 mm	8000
170-14A	60	2,40	L	M5	53,3	11 x 22 mm	8000
170-15	65	2,60	R	M4	57,7	11 x 22 mm	6600
170-16	65	2,60	L	M4	57,7	11 x 22 mm	6600
170-15A	65	2,60	R	M5	57,7	11 x 22 mm	6600
170-16A	65	2,60	L	M5	57,7	11 x 22 mm	6600
170-17	70	2,80	R	M4	62,2	12 x 24 mm	6200
170-18	70	2,80	L	M4	62,2	12 x 24 mm	6200
170-17A	70	2,80	R	M5	62,2	12 x 24 mm	6200
170-18A	70	2,80	L	M5	62,2	12 x 24 mm	6200

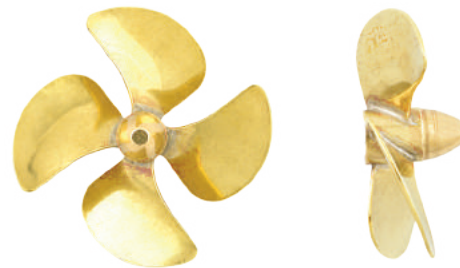

171 / C-type



## 171 - 4 blade

## INCH shaft connection

Code	D mm	D inch	R/L	shaft thread	pitch mm	Hub Ø x Length	RPM max.
171-05	40	1,60	R	3/16	35,6	9 x 16 mm	13000
171-06	40	1,60	L	3/16	35,6	9 x 16 mm	13000
171-07	45	1,80	R	3/16	40,0	9 x 16 mm	12000
171-08	45	1,80	L	3/16	40,0	9 x 16 mm	12000
171-09	50	2,00	R	3/16	44,5	10 x 18 mm	10000
171-10	50	2,00	L	3/16	44,5	10 x 18 mm	10000
171-11	55	2,20	R	3/16	49,0	10 x 18 mm	9600
171-12	55	2,20	L	3/16	49,0	10 x 18 mm	9600
171-13	60	2,40	R	3/16	53,3	11 x 22 mm	8000
171-14	60	2,40	L	3/16	53,3	11 x 22 mm	8000
171-15	65	2,60	R	3/16	57,7	11 x 22 mm	6600
171-16	65	2,60	L	3/16	57,7	11 x 22 mm	6600
171-17	70	2,80	R	3/16	62,2	12 x 24 mm	6200
171-18	70	2,80	L	3/16	62,2	12 x 24 mm	6200

# Brass propellers

Messing sloopsschroeven - Messing Schiffsschrauben - Hélices laiton

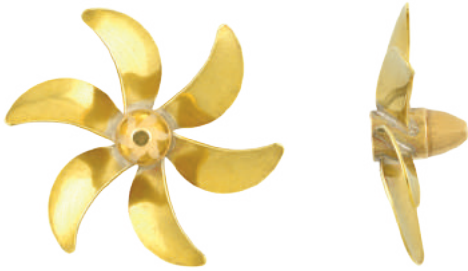

172 / B-type

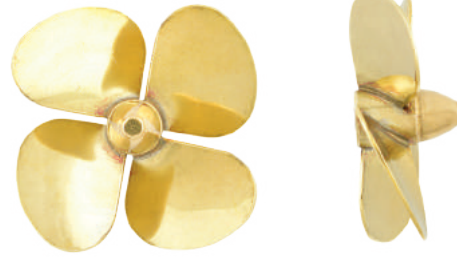

174 / D-type



## 172 - 6 blade METRIC shaft connection

Code	D mm	D inch	R/L	shaft thread	pitch mm	Hub Ø x Length	RPM max.
172-05	40	1,60	R	M4	41,0	9 x 16 mm	13000
172-06	40	1,60	L	M4	41,0	9 x 16 mm	13000
172-07	45	1,80	R	M4	46,1	9 x 16 mm	12000
172-08	45	1,80	L	M4	46,1	9 x 16 mm	12000
172-09	50	2,00	R	M4	51,2	10 x 18 mm	10000
172-10	50	2,00	L	M4	51,2	10 x 18 mm	10000
172-11	55	2,20	R	M4	56,4	10 x 18 mm	9600
172-12	55	2,20	L	M4	56,4	10 x 18 mm	9600
172-13	60	2,40	R	M4	61,5	11 x 22 mm	8000
172-14	60	2,40	L	M4	61,5	11 x 22 mm	8000
172-13A	60	2,40	R	M5	61,5	11 x 22 mm	8000
172-14A	60	2,40	L	M5	61,5	11 x 22 mm	8000
172-15	65	2,60	R	M4	66,6	11 x 22 mm	6600
172-16	65	2,60	L	M4	66,6	11 x 22 mm	6600
172-15A	65	2,60	R	M5	66,6	11 x 22 mm	6600
172-16A	65	2,60	L	M5	66,6	11 x 22 mm	6600
172-17	70	2,80	R	M4	71,7	12 x 24 mm	6200
172-18	70	2,80	L	M4	71,7	12 x 24 mm	6200
172-17A	70	2,80	R	M5	71,7	12 x 24 mm	6200
172-18A	70	2,80	L	M5	71,7	12 x 24 mm	6200

## 174 - 4 blade METRIC shaft connection

Code	D mm	D inch	R/L	shaft thread	pitch mm	Hub Ø x Length	RPM max.
174-41	20	0,79	R	M2	20,5	6 x 10 mm	16000
174-42	20	0,79	L	M2	20,5	6 x 10 mm	16000
174-43	20	0,79	R	M3	20,5	6 x 10 mm	16000
174-44	20	0,79	L	M3	20,5	6 x 10 mm	16000
174-45	25	0,98	R	M2	25,6	7 x 12 mm	16000
174-46	25	0,98	L	M2	25,6	7 x 12 mm	16000
174-47	25	0,98	R	M3	25,6	7 x 12 mm	16000
174-48	25	0,98	L	M3	25,6	7 x 12 mm	16000
174-49	25	0,98	R	M4	25,6	7 x 12 mm	16000
174-50	25	0,98	L	M4	25,6	7 x 12 mm	16000
174-01	30	1,20	R	M4	26,7	8 x 14,5 mm	14500
174-02	30	1,20	L	M4	26,7	8 x 14,5 mm	14500
174-01A	30	1,20	R	M3	26,7	8 x 14,5 mm	14500
174-02A	30	1,20	L	M3	26,7	8 x 14,5 mm	14500
174-03	35	1,40	R	M4	31,1	8 x 14,5 mm	14500
174-04	35	1,40	L	M4	31,1	8 x 14,5 mm	14500
174-03A	35	1,40	R	M3	31,1	8 x 14,5 mm	14500
174-04A	35	1,40	L	M3	31,1	8 x 14,5 mm	14500
174-05	40	1,60	R	M4	35,6	9 x 16 mm	13000
174-06	40	1,60	L	M4	35,6	9 x 16 mm	13000
174-07	45	1,80	R	M4	40,0	9 x 16 mm	12000
174-08	45	1,80	L	M4	40,0	9 x 16 mm	12000
174-09	50	2,00	R	M4	44,5	10 x 18 mm	10000
174-10	50	2,00	L	M4	44,5	10 x 18 mm	10000
174-11	55	2,20	R	M4	49,0	10 x 18 mm	9600
174-12	55	2,20	L	M4	49,0	10 x 18 mm	9600
174-13	60	2,40	R	M4	53,3	11 x 22 mm	8000
174-14	60	2,40	L	M4	53,3	11 x 22 mm	8000
174-13A	60	2,40	R	M5	53,3	11 x 22 mm	8000
174-14A	60	2,40	L	M5	53,3	11 x 22 mm	8000



173 / B-type



## 173 - 6 blade INCH shaft connection

Code	D mm	D inch	R/L	shaft thread	pitch mm	Hub Ø x Length	RPM max.
173-05	40	1,60	R	3/16	41,0	9 x 16 mm	13000
173-06	40	1,60	L	3/16	41,0	9 x 16 mm	13000
173-07	45	1,80	R	3/16	46,1	9 x 16 mm	12000
173-08	45	1,80	L	3/16	46,1	9 x 16 mm	12000
173-09	50	2,00	R	3/16	51,2	10 x 18 mm	10000
173-10	50	2,00	L	3/16	51,2	10 x 18 mm	10000
173-11	55	2,20	R	3/16	56,4	10 x 18 mm	9600
173-12	55	2,20	L	3/16	56,4	10 x 18 mm	9600

# Brass propellers

Messing sloopsschroeven - Messing Schiffsschrauben - Hélices laiton



175 / D-type



## 175 - 4 blade

## INCH shaft connection

Code	D mm	D inch	R/L	shaft thread	pitch mm	Hub Ø x Length	RPM max.
175-01	30	1,20	R	3/16	26,7	8 x 14,5 mm	14500
175-02	30	1,20	L	3/16	26,7	8 x 14,5 mm	14500
175-03	35	1,40	R	3/16	31,1	8 x 14,5 mm	14500
175-04	35	1,40	L	3/16	31,1	8 x 14,5 mm	14500
175-05	40	1,60	R	3/16	35,6	9 x 16 mm	13000
175-06	40	1,60	L	3/16	35,6	9 x 16 mm	13000
175-07	45	1,80	R	3/16	40,0	9 x 16 mm	12000
175-08	45	1,80	L	3/16	40,0	9 x 16 mm	12000
175-09	50	2,00	R	3/16	44,5	10 x 18 mm	10000
175-10	50	2,00	L	3/16	44,5	10 x 18 mm	10000
175-11	55	2,20	R	3/16	49,0	10 x 18 mm	9600
175-12	55	2,20	L	3/16	49,0	10 x 18 mm	9600
175-13	60	2,40	R	3/16	53,3	11 x 22 mm	8000
175-14	60	2,40	L	3/16	53,3	11 x 22 mm	8000

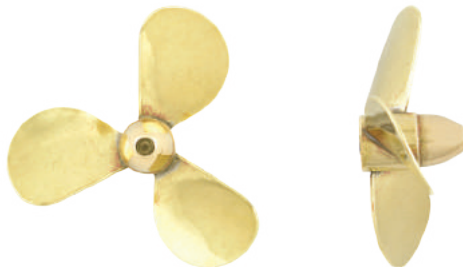

176 / A-type



## 176 - 3 blade

## INCH shaft connection

Code	D mm	D inch	R/L	shaft thread	pitch mm	Hub Ø x Length	RPM max.
176-39	20	0,79	R	1/8	20,5	6 x 10 mm	16000
176-40	20	0,79	L	1/8	20,5	6 x 10 mm	16000
176-41	25	0,98	R	1/8	25,6	7 x 12 mm	16000
176-42	25	0,98	L	1/8	25,6	7 x 12 mm	16000
176-43	30	1,20	R	1/8	30,7	8 x 14,5 mm	14500
176-44	30	1,20	L	1/8	30,7	8 x 14,5 mm	14500
176-01	30	1,20	R	3/16	30,7	8 x 14,5 mm	14500
176-02	30	1,20	L	3/16	30,7	8 x 14,5 mm	14500
176-45	35	1,40	R	1/8	35,9	8 x 14,5 mm	14500
176-46	35	1,40	L	1/8	35,9	8 x 14,5 mm	14500
176-03	35	1,40	R	3/16	35,9	8 x 14,5 mm	14500
176-04	35	1,40	L	3/16	35,9	8 x 14,5 mm	14500
176-05	40	1,60	R	3/16	41,0	9 x 16 mm	13000
176-06	40	1,60	L	3/16	41,0	9 x 16 mm	13000
176-07	45	1,80	R	3/16	46,1	9 x 16 mm	12000
176-08	45	1,80	L	3/16	46,1	9 x 16 mm	12000
176-11	50	2,00	R	3/16	51,2	10 x 18 mm	10000
176-12	50	2,00	L	3/16	51,2	10 x 18 mm	10000
176-15	55	2,20	R	3/16	56,4	10 x 18 mm	9600
176-16	55	2,20	L	3/16	56,4	10 x 18 mm	9600

## 176 - 3 blade

## INCH shaft connection

Code	D mm	D inch	R/L	shaft thread	pitch mm	Hub Ø x Length	RPM max.
176-19	60	2,40	R	3/16	61,5	11 x 22 mm	8000
176-20	60	2,40	L	3/16	61,5	11 x 22 mm	8000
176-21	65	2,60	R	3/16	66,6	11 x 22 mm	6600
176-22	65	2,60	L	3/16	66,6	11 x 22 mm	6600
176-23	70	2,80	R	3/16	71,7	12 x 24 mm	6200
176-24	70	2,80	L	3/16	71,7	12 x 24 mm	6200
176-25	75	3,00	R	3/16	76,9	12 x 24 mm	4200
176-26	75	3,00	L	3/16	76,9	12 x 24 mm	4200
176-27	80	3,20	R	3/16	82,0	14 x 26 mm	3500
176-28	80	3,20	L	3/16	82,0	14 x 26 mm	3500
176-29	90	3,60	R	3/16	92,2	14 x 28 mm	3100
176-30	90	3,60	L	3/16	92,2	14 x 28 mm	3100

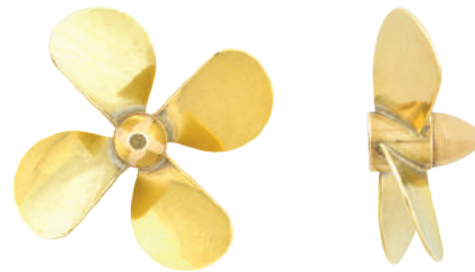

177 / A-type



## 177 - 4 blade

## INCH shaft connection

Code	D mm	D inch	R/L	shaft thread	pitch mm	Hub Ø x Length	RPM max.
177-39	20	0,79	R	1/8	20,5	6 x 10 mm	16000
177-40	20	0,79	L	1/8	20,5	6 x 10 mm	16000
177-41	25	0,98	R	1/8	25,6	7 x 12 mm	16000
177-42	25	0,98	L	1/8	25,6	7 x 12 mm	16000
177-43	30	1,20	R	1/8	30,7	8 x 14,5 mm	14500
177-44	30	1,20	L	1/8	30,7	8 x 14,5 mm	14500
177-01	30	1,20	R	3/16	30,7	8 x 14,5 mm	14500
177-02	30	1,20	L	3/16	30,7	8 x 14,5 mm	14500
177-45	35	1,40	R	1/8	35,9	8 x 14,5 mm	14500
177-46	35	1,40	L	1/8	35,9	8 x 14,5 mm	14500
177-03	35	1,40	R	3/16	35,9	8 x 14,5 mm	14500
177-04	35	1,40	L	3/16	35,9	8 x 14,5 mm	14500
177-05	40	1,60	R	3/16	41,0	9 x 16 mm	13000
177-06	40	1,60	L	3/16	41,0	9 x 16 mm	13000
177-07	45	1,80	R	3/16	46,1	9 x 16 mm	12000
177-08	45	1,80	L	3/16	46,1	9 x 16 mm	12000
177-11	50	2,00	R	3/16	51,2	10 x 18 mm	10000
177-12	50	2,00	L	3/16	51,2	10 x 18 mm	10000
177-15	55	2,20	R	3/16	56,4	10 x 18 mm	9600
177-16	55	2,20	L	3/16	56,4	10 x 18 mm	9600
177-19	60	2,40	R	3/16	61,5	11 x 22 mm	8000
177-20	60	2,40	L	3/16	61,5	11 x 22 mm	8000
177-21	65	2,60	R	3/16	66,6	11 x 22 mm	6600
177-22	65	2,60	L	3/16	66,6	11 x 22 mm	6600
177-23	70	2,80	R	3/16	71,7	12 x 24 mm	6200
177-24	70	2,80	L	3/16	71,7	12 x 24 mm	6200
177-25	75	3,00	R	3/16	76,9	12 x 24 mm	4200
177-26	75	3,00	L	3/16	76,9	12 x 24 mm	4200
177-27	80	3,20	R	3/16	82,0	14 x 26 mm	3500
177-28	80	3,20	L	3/16	82,0	14 x 26 mm	3500
177-29	90	3,60	R	3/16	92,2	14 x 28 mm	3100
177-30	90	3,60	L	3/16	92,2	14 x 28 mm	3100

# Brass propellers

Messing sloopsschroeven - Messing Schiffsschrauben - Hélices laiton



178 / A-type



180 / B-type



## 178 - 5 blade

## INCH shaft connection

Code	D mm	D inch	R/L	shaft thread	pitch mm	Hub Ø x Length	RPM max.
178-01	30	1,20	R	3/16	30,7	8 x 14,5 mm	14500
178-02	30	1,20	L	3/16	30,7	8 x 14,5 mm	14500
178-03	35	1,40	R	3/16	35,9	8 x 14,5 mm	14500
178-04	35	1,40	L	3/16	35,9	8 x 14,5 mm	14500
178-05	40	1,60	R	3/16	41,0	9 x 16 mm	13000
178-06	40	1,60	L	3/16	41,0	9 x 16 mm	13000
178-07	45	1,80	R	3/16	46,1	9 x 16 mm	12000
178-08	45	1,80	L	3/16	46,1	9 x 16 mm	12000
178-09	50	2,00	R	3/16	51,2	10 x 18 mm	10000
178-10	50	2,00	L	3/16	51,2	10 x 18 mm	10000
178-11	55	2,20	R	3/16	56,4	10 x 18 mm	9600
178-12	55	2,20	L	3/16	56,4	10 x 18 mm	9600
178-13	60	2,40	R	3/16	61,5	11 x 22 mm	8000
178-14	60	2,40	L	3/16	61,5	11 x 22 mm	8000
178-15	65	2,60	R	3/16	66,6	11 x 22 mm	6600
178-16	65	2,60	L	3/16	66,6	11 x 22 mm	6600
178-17	70	2,80	R	3/16	71,7	12 x 24 mm	6200
178-18	70	2,80	L	3/16	71,7	12 x 24 mm	6200

## 180 - 7 blade

## INCH shaft connection side screw M3 x 4mm included

Code	D mm	D inch	R/L	shaft hole	Hub Ø x Length	RPM max.
180-13	53	2,08	R	Ø 3/16	18 x 25 mm	9600
180-14	53	2,08	L	Ø 3/16	18 x 25 mm	9600
180-15	58	2,28	R	Ø 3/16	18 x 25 mm	8000
180-16	58	2,28	L	Ø 3/16	18 x 25 mm	8000
180-17	63	2,48	R	Ø 3/16	19 x 26 mm	6600
180-18	63	2,48	L	Ø 3/16	19 x 26 mm	6600
180-19	68	2,68	R	Ø 3/16	19 x 26 mm	6200
180-20	68	2,68	L	Ø 3/16	19 x 26 mm	6200
180-23	73	2,87	R	Ø 3/16	20 x 27 mm	4200
180-24	73	2,87	L	Ø 3/16	20 x 27 mm	4200
180-27	78	3,07	R	Ø 3/16	20 x 27 mm	3500
180-28	78	3,07	L	Ø 3/16	20 x 27 mm	3500



179 / B-type



181 / A-type



## 179 - 7 blade

## METRIC shaft connection

Code	D mm	D inch	R/L	shaft thread	Hub Ø x Length	RPM max.
179-13	53	2,08	R	M5	18 x 25 mm	9600
179-14	53	2,08	L	M5	18 x 25 mm	9600
179-15	58	2,28	R	M5	18 x 25 mm	8000
179-16	58	2,28	L	M5	18 x 25 mm	8000
179-17	63	2,48	R	M5	19 x 26 mm	6600
179-18	63	2,48	L	M5	19 x 26 mm	6600
179-19	68	2,68	R	M5	19 x 26 mm	6200
179-20	68	2,68	L	M5	19 x 26 mm	6200
179-23	73	2,87	R	M5	20 x 27 mm	4200
179-24	73	2,87	L	M5	20 x 27 mm	4200
179-27	78	3,07	R	M5	20 x 27 mm	3500
179-28	78	3,07	L	M5	20 x 27 mm	3500

## 181 - 5 blade

## METRIC shaft connection

Code	D mm	D inch	R/L	shaft thread	Hub Ø x Length	RPM max.
181-13	55	2,2	R	M4	15x22 mm	9600
181-14	55	2,2	L	M4	15x22 mm	9600
181-13A	55	2,2	R	M5	15x22 mm	9600
181-14A	55	2,2	L	M5	15x22 mm	9600
181-15	60	2,4	R	M4	16x23 mm	8000
181-16	60	2,4	L	M4	16x23 mm	8000
181-15A	60	2,4	R	M5	16x23 mm	8000
181-16A	60	2,4	L	M5	16x23 mm	8000
181-17	65	2,6	R	M5	17x24 mm	6600
181-18	65	2,6	L	M5	17x24 mm	6600
181-19	70	2,8	R	M5	17x24 mm	6200
181-20	70	2,8	L	M5	17x24 mm	6200
181-21	75	3,0	R	M5	18x25 mm	4200
181-22	75	3,0	L	M5	18x25 mm	4200
181-23	80	3,2	R	M5	19x26 mm	3500
181-24	80	3,2	L	M5	19x26 mm	3500
181-25	85	3,4	R	M5	20x27 mm	3100
181-26	85	3,4	L	M5	20x27 mm	3100
181-27	95	3,8	R	M5	20x27 mm	2800
181-28	95	3,8	L	M5	20x27 mm	2800

# Brass propellers

Messing sloopsschroeven - Messing Schiffsschrauben - Hélices laiton



183 / C-type



186 / B-type



## 183 - 5 blade

## METRIC shaft connection

Code	D mm	D inch	R/L	shaft thread	pitch mm	Hub Ø x Length	RPM max.
183-13	55	2,2	R	M4		15x22 mm	9600
183-14	55	2,2	L	M4		15x22 mm	9600
183-13A	55	2,2	R	M5		15x22 mm	9600
183-14A	55	2,2	L	M5		15x22 mm	9600
183-15	60	2,4	R	M4		16x23 mm	8000
183-16	60	2,4	L	M4		16x23 mm	8000
183-15A	60	2,4	R	M5		16x23 mm	8000
183-16A	60	2,4	L	M5		16x23 mm	8000
183-17	65	2,6	R	M5		17x24 mm	6600
183-18	65	2,6	L	M5		17x24 mm	6600
183-19	70	2,8	R	M5		18x25 mm	6200
183-20	70	2,8	L	M5		18x25 mm	6200
183-21	75	3,0	R	M5		19x26 mm	4200
183-22	75	3,0	L	M5		19x26 mm	4200

## 186 - 7 blade

## INCH shaft connection

Code	D mm	D inch	R/L	shaft thread	pitch mm	Hub Ø x Length	RPM max.
186-05	40	1,60	R	3/16	41,0	9 x 16 mm	13000
186-06	40	1,60	L	3/16	41,0	9 x 16 mm	13000
186-07	45	1,80	R	3/16	46,1	9 x 16 mm	12000
186-08	45	1,80	L	3/16	46,1	9 x 16 mm	12000
186-09	50	2,00	R	3/16	51,2	10 x 18 mm	10000
186-10	50	2,00	L	3/16	51,2	10 x 18 mm	10000
186-11	55	2,20	R	3/16	56,4	10 x 18 mm	9600
186-12	55	2,20	L	3/16	56,4	10 x 18 mm	9600



185 / B-type



## 185 - 7 blade

## METRIC shaft connection

Code	D mm	D inch	R/L	shaft thread	pitch mm	Hub Ø x Length	RPM max.
185-05	40	1,60	R	M4	41,0	9 x 16 mm	13000
185-06	40	1,60	L	M4	41,0	9 x 16 mm	13000
185-07	45	1,80	R	M4	46,1	9 x 16 mm	12000
185-08	45	1,80	L	M4	46,1	9 x 16 mm	12000
185-09	50	2,00	R	M4	51,2	10 x 18 mm	10000
185-10	50	2,00	L	M4	51,2	10 x 18 mm	10000
185-11	55	2,20	R	M4	56,4	10 x 18 mm	9600
185-12	55	2,20	L	M4	56,4	10 x 18 mm	9600
185-13	60	2,40	R	M4	61,5	11 x 22 mm	8000
185-14	60	2,40	L	M4	61,5	11 x 22 mm	8000
185-13A	60	2,40	R	M5	61,5	11 x 22 mm	8000
185-14A	60	2,40	L	M5	61,5	11 x 22 mm	8000
185-15	65	2,60	R	M4	66,6	11 x 22 mm	6600
185-16	65	2,60	L	M4	66,6	11 x 22 mm	6600
185-15A	65	2,60	R	M5	66,6	11 x 22 mm	6600
185-16A	65	2,60	L	M5	66,6	11 x 22 mm	6600
185-17	70	2,80	R	M4	71,7	12 x 24 mm	6200
185-18	70	2,80	L	M4	71,7	12 x 24 mm	6200
185-17A	70	2,80	R	M5	71,7	12 x 24 mm	6200
185-18A	70	2,80	L	M5	71,7	12 x 24 mm	6200

# Brass propellers Raboesch special series



hobby products



140 - 06



140 - 06

6 blade propeller  
for RC Submarine Neptune SB-1

METRIC shaft connection  
side screw M2,5 x 3mm included

Code	D mm	D inch	R/L	shaft hole	pitch mm	Hub Ø x Length	RPM max.
140-06	40	1.60	L	Ø 4 mm	41,0	9 x 14mm	13000

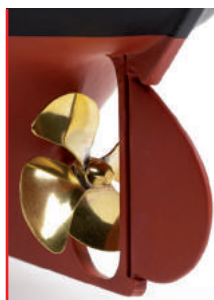

140 - 11>12



140 - 11>12

4 blade front and rear propeller  
for Billing Boats Elbjorn Icebreaker

METRIC shaft connection

Code	D mm	D inch	R/L	shaft thread	pitch mm	Hub Ø x Length	RPM max.
140-11	29	1.14	R	M3	26,7	7 x 12 mm	16000
140-12	49	1.92	R	M3	44,5	8 x 15 mm	16000



140 - 13>14



140 - 13>14

3 blade propeller  
for KRVE 1:22,5 scale Mooring Tug

METRIC shaft connection  
M3 Hexagon bolt included

Code	D mm	D inch	R/L	shaft thread	pitch mm	Hub Ø x Length	RPM max.
140-13	34	1.33	R	M3	31,1	7 x 7,5 mm	14000
140-14	34	1.33	L	M3	31,1	7 x 7,5 mm	14000

NEW - NIEUW 2024



140 - 15>16



140 - 15>16

4 blade propeller  
for KRVE 1:22,5 scale Mooring Tug

METRIC shaft connection  
M3 Hexagon bolt included

Code	D mm	D inch	R/L	shaft thread	pitch mm	Hub Ø x Length	RPM max.
140-15	34	1.33	R	M3	31,1	7 x 7,5 mm	14000
140-16	34	1.33	L	M3	31,1	7 x 7,5 mm	14000

NEW - NIEUW 2024

184 - 13



www.engel-modellbau.de

184 - 13

6 blade propeller  
for Type 212A Class RC Submarine

METRIC shaft connection

Code	D mm	D inch	R/L	shaft thread	pitch mm	Hub Ø x Length	RPM max.
184-13	60	2,40	R	M4	71,7	12 x 12mm	8000

# Rubber Bumper profile

Rubber stootrand profiel - Gummi Stoßfänger Profile -  
Liston de protection en caoutchouc

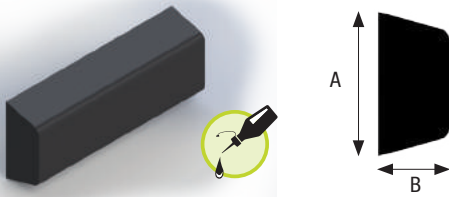

## 104-10 > 19 Rubber bump profile Rhombus absorbers

Code	A mm	B mm	° shore	length	content
104-11	4	2	60°	200cm	1
104-12	6	3	60°	200cm	1
104-13	8	4	60°	200cm	1
104-14	10	5	60°	200cm	1

NEW - NIEUW 2024

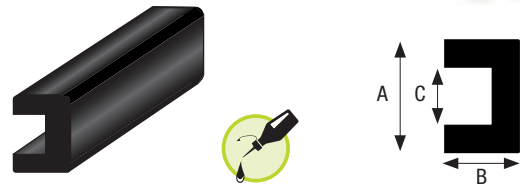
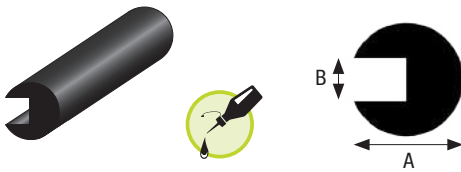

## 104-30 > 34 Rubber bump profile round absorbers

Code	A mm	B mm	° shore	length	content
104-30	Ø 2	0,5	60°	200 cm	1
104-31	Ø 4	1	60°	200 cm	1
104-32	Ø 6	1	60°	200 cm	1
104-33	Ø 8	2	60°	200 cm	1
104-34	Ø 10	2	60°	200 cm	1

## 104-50 > 54 Rubber bump profile square absorbers

Code	A mm	B mm	C mm	° shore	length	content
104-50	2	2	0,75	60°	200 cm	1
104-51	4	3	1,5	60°	200 cm	1
104-52	6	4	3	60°	200 cm	1
104-53	8	4,8	4	60°	200 cm	1
104-54	10	7	6	60°	200 cm	1

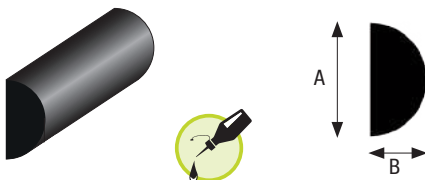

## 104-60 > 64 Rubber bump profile half round absorbers

Code	A mm	B mm	° shore	length	content
104-60	2	1,1	60°	200 cm	1
104-61	4	2,1	60°	200 cm	1
104-62	6	3,1	60°	200 cm	1
104-63	8	4,2	60°	200 cm	1
104-64	10	5,2	60°	200 cm	1

## 104-72 > 74 Rubber bump profile rounded square absorbers

Code	A mm	B mm	C mm	° shore	length	content
104-72	6	5	2	60°	200 cm	1
104-73	8	7	3	60°	200 cm	1
104-74	10	9	4	60°	200 cm	1

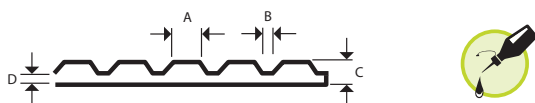

## 104-26 > 27 Rubber bump sheet

Code	Name	L x W mm	A mm	B mm	C mm	D mm	cont.
104-26	Sirius	600 x 120	12	6	6	3	1
104-27	Titan	660 x 150	13	5	6	4	1

NEW - NIEUW 2024

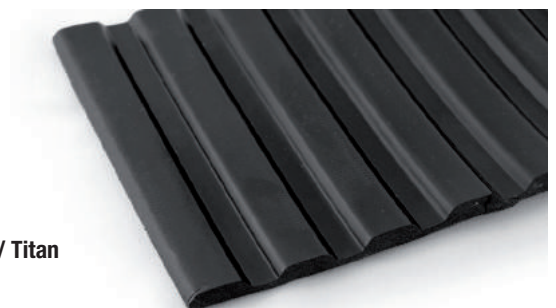

Sirius / Titan



# Rubber Bumper sheet

Rubber stootrand plaat - Gummi Stoßfänger Platte -  
Liston de protection en caoutchouc



## 104-21 > 24 Rubber bump sheet

Code	Name	L x W	° shore	A mm	B mm	C mm	D mm	content
104-21	Tender	300 x 75 mm	60°	1,7	1,5	3	1,7	1
104-23	Polar	300 x 75 mm	70°	3	3,5	3,1	1,6	1
104-24	Triton	300 x 100 mm	45°	3,5	4,2	8,5	4,8	1

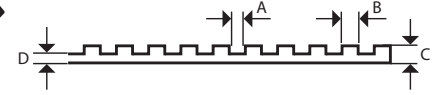

**Tender**  
104-21

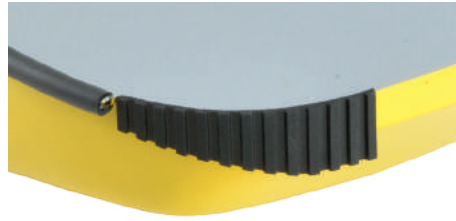

**Polar**  
104-23

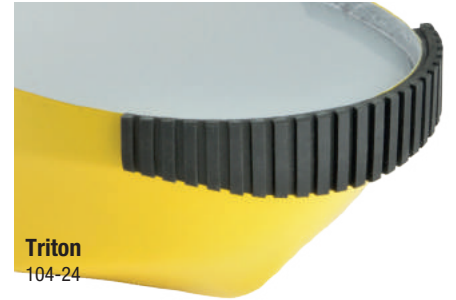

**Triton**  
104-24

## Styreen stootrand profiel - Styrol Stoßfänger Profile - Liston de protection en Styrene

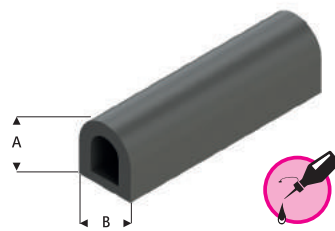
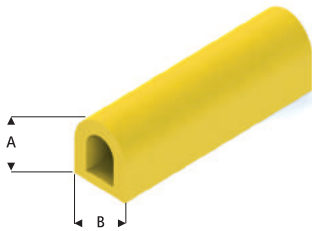

### 103-03 > 06

### Styrene bump profile absorbers

Code	A mm	B mm	Color	length	content
103-03	6,6	6,6	Yellow	60 cm	2
103-04	6,6	6,6	Black	60 cm	2
103-05	7,75	6,75	Black	60 cm	2
103-06	7,75	6,75	Yellow	60 cm	2

NEW - NIEUW 2024



Profiles & Sheets

## Styrol Spundwandprofile - Styrene Sheet Pile Profiles - Styreen Damwand profielen - Profil De Palplanche



### LARGE

length 100 cm / 39.4 inch

art. nr.	mm				Quantity	
	A	B	C	D	Scale	in package

#### sheet pile profile

470-51	3.2	8.2	5.4	1.9	1:160 N	3
470-54	5.4	17.4	11.2	3.5	1:87 HO	3
470-56	9.6	33.6	23.5	7.5	1:45 O	2
470-57	13.8	46.9	33.1	10.5	1:32 I	2
470-58	19.6	66.8	45.2	14.9	1:22.5 G	2

### SMALL

length 33 cm / 13 inch

art. nr.	mm				Quantity	
	A	B	C	D	Scale	in package

#### sheet pile profile

470-51/3	3.2	8.2	5.4	1.9	1:160 N	5
470-54/3	5.4	17.4	11.2	3.5	1:87 HO	5

### MEDIUM

length 60 cm / 23.6 inch

art. nr.	mm				Quantity	
	A	B	C	D	Scale	in package

#### sheet pile profile

470-56/6	9.6	33.6	23.52	7.5	1:45 O	2
470-57/6	13.8	46.9	33.1	10.5	1:32 I	2
470-58/6	19.6	66.8	45.2	14.94	1:22.5 G	2

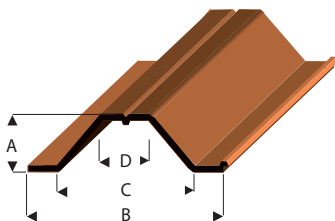

NEW - NIEUW 2024

# Electric Motors

Electrische motoren - Elektromotoren - Moteurs Électriques

## 109 - 13 Blue RM130 Brushed Motor 12 Volt

RM-100 Series



Nom. Voltage: 12V  
Voltage Range: 6-12V  
Shaft: Ø 2 mm  
Weight: 22 gr

	No load	Max. Efficiency	Max. Output
Current:	10 mA	0,6 A	0,7 A
Speed:	15.500 Rpm	9250 Rpm	4300 Rpm

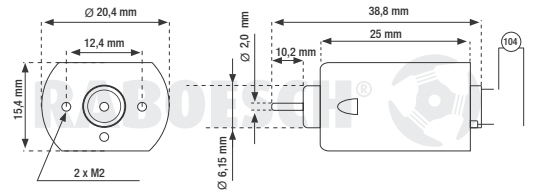

## 109 - 40 Blue RM400 Brushed Motor 6 Volt

RM-400 Series



Nom. Voltage: 6V  
Voltage Range: 3-6V  
Shaft: Ø 2,3 mm  
Weight: 72 gr

	No load	Max. Efficiency	Max. Output
Current:	0,8 A	1,6 A	3,4 A
Speed:	17.000 Rpm	7300 Rpm	4200 Rpm

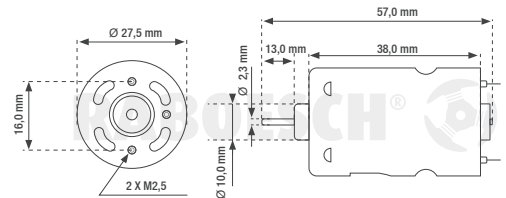

## 109 - 41 Blue RM410 Brushed Motor 7,2 Volt

RM-400 Series



Nom. Voltage: 7,2V  
Voltage Range: 6-9V  
Shaft: Ø 2,3 mm  
Weight: 72 gr

	No load	Max. Efficiency	Max. Output
Current:	0,7 A	1,3 A	3,2 A
Speed:	17.000 Rpm	7500 Rpm	4300 Rpm

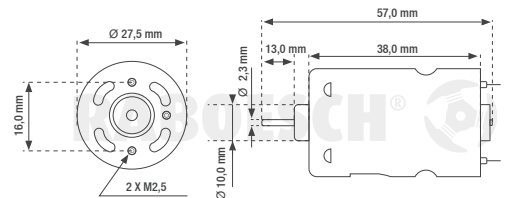

## 109 - 43 Blue RM430 Brushed Motor 12 Volt

RM-400 Series



Nom. Voltage: 12V  
Voltage Range: 6-16V  
Shaft: Ø 2,3 mm  
Weight: 72 gr

	No load	Max. Efficiency	Max. Output
Current:	0,56 A	1,3 A	2,9 A
Speed:	16.500 Rpm	8000 Rpm	4500 Rpm

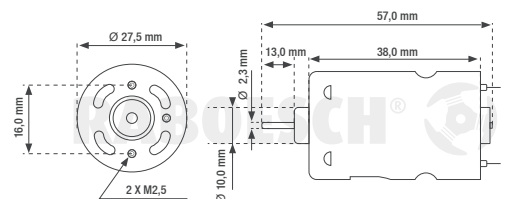

**109 - 51 Blue RM 510 TRQ Brushed Motor 7,2 Volt**

**RM-500 Series**



Nom. Voltage: 7,2V  
Voltage Range: 6-9V  
Shaft: Ø 3,2 mm  
Weight: 174 gr

	No load	Max. Efficiency	Max. Output
Current:	0,7 A	1,6 A	2,2 A
Speed:	7.600 Rpm	7.000 Rpm	5.800 Rpm

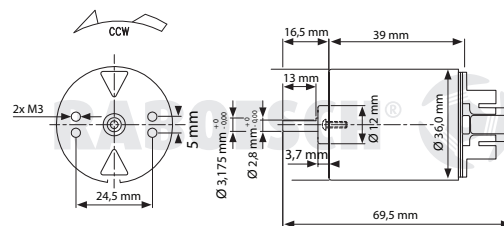

**109 - 53 Blue RM 530 TRQ Brushed Motor 7,2 Volt**

**RM-500 Series**



Nom. Voltage: 7,2V  
Voltage Range: 6-9V  
Shaft: Ø 3,2 mm  
Weight: 174 gr

	No load	Max. Efficiency	Max. Output
Current:	1,2 A	1,9 A	2,9 A
Speed:	12.000 Rpm	10.500 Rpm	8.200 Rpm

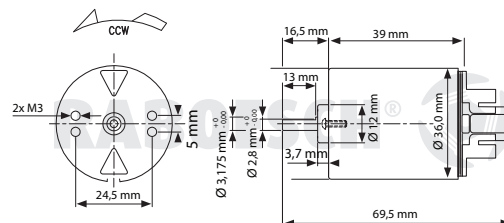

**109 - 72 Blue RM 720 BB Turbo Brushed Motor 9,6 Volt**

**RM-700 Series**



Nom. Voltage: 9,6V  
Voltage Range: 3-9,6V  
Shaft: Ø 5 mm  
Weight: 352 gr

	No load	Max. Efficiency
Current:	2,0 A	6,3 A
Speed:	15.000 Rpm	6.700 Rpm

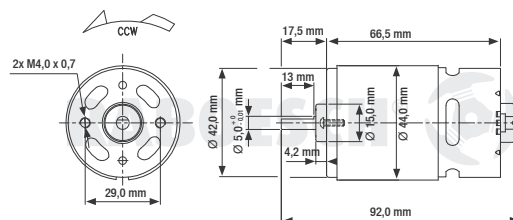

**109 - 73 Blue RM730TRQ Brushed Motor 12 Volt**

**RM-700 Series**



Nom. Voltage: 12V  
Voltage Range: 6-12V  
Shaft: Ø 5 mm  
Weight: 352 gr

	No load	Max. Efficiency
Current:	0,40 A	2,3 A
Speed:	4500 Rpm	3820 Rpm

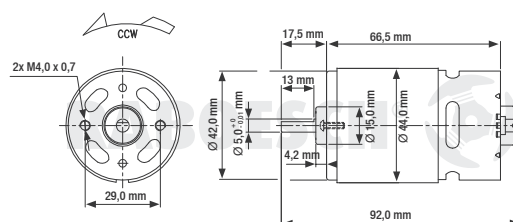

# Bow Thrusters

Boegschroeven - Querstrahlruder - Propulseurs d'étrave

Code	A	B	C	D	d	E	F	Max flow at 7,2V
108-01	Ø 22 mm	66 mm	11 mm	Ø 16 mm	Ø 14 mm	31 mm	Ø 40 mm	L/P min at 7,2V
108-02	Ø 22 mm	66 mm	11 mm	Ø 19 mm	Ø 16 mm	31 mm	Ø 40 mm	L/P min at 7,2V
108-03	Ø 22 mm	66 mm	11 mm	Ø 22 mm	Ø 19 mm	31 mm	Ø 40 mm	L/P min at 7,2V
108-04	Ø 28 mm	72 mm	14 mm	Ø 25 mm	Ø 22 mm	34 mm	Ø 40 mm	L/P min at 7,2V
108-05	Ø 28 mm	72 mm	14 mm	Ø 28 mm	Ø 25 mm	34 mm	Ø 40 mm	L/P min at 7,2V

These very powerful bow thrusters are supplied fully mounted with a Blue RM-410 7.2-Volt electrical motor, 11 Amp. max. The propulsion is provided by a flat impeller (paddle) which pressurizes the water through jet nozzles whereby the entire assembly functions as a pump. This design is very robust and very stable and requires very little maintenance. The pump housing and the extension tubes are made of ABS (acrylonitrile butadiene styrene). The motor is sealed with a G-ring and an O-ring which prevents the entry of water whereby the bow thruster can be installed vertically as well as horizontally. The motor with the pump housing cover can be removed easily. The cover has an O-ring that ensures water-tight sealing of the entire assembly. For further technical information: See the dimensional drawing and the technical details of the motor. Blue RM-410 electrical motor. Max. RPM 17.000 – voltage without load: 0.5 Amps Highest performance: 78% - Motor shaft: 2.3 x 12 mm. For spare parts see page 22.

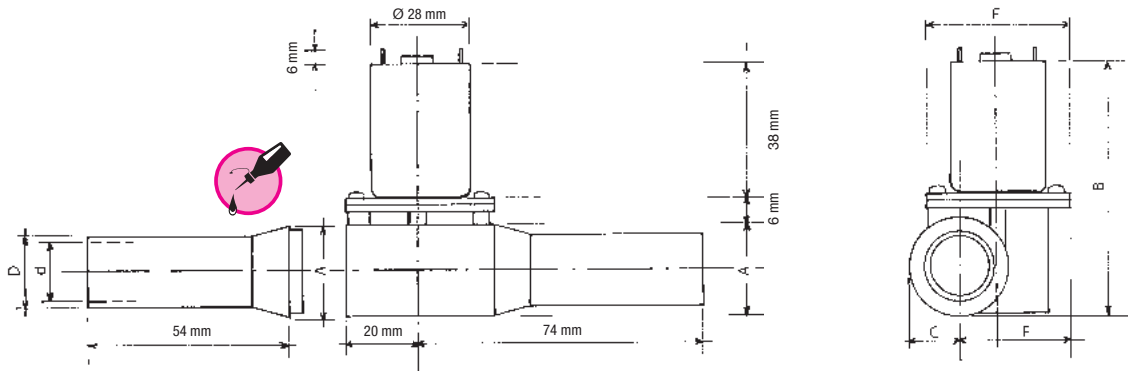

108-01



108-04



108-02



108-05



108-03



Optional motors  
6V code 109-40  
12V code 109-43  
see page 15

For spare parts see page 25.

# Bow Thrusters

Boegschroeven - Querstrahlruder - Propulseurs d'étrave

108-20

108-20

The world's smallest bow thruster.  
 Blue RM-130 3-12 volt, 6 Amp max. (See page 16: art. 109-13)  
 Max. flow: 5,5 L/P min at 12 Volt  
 Material: ABS.  
 A G-ring ensures water tightness.  
 Jet Nozzle diameter  $\varnothing$  10 x 12mm.  
 Smallest installation breadth: 21mm.  
 Total length: 90mm.  
 Total height: 46 mm.  
 Weight 30 gr incl. motor.

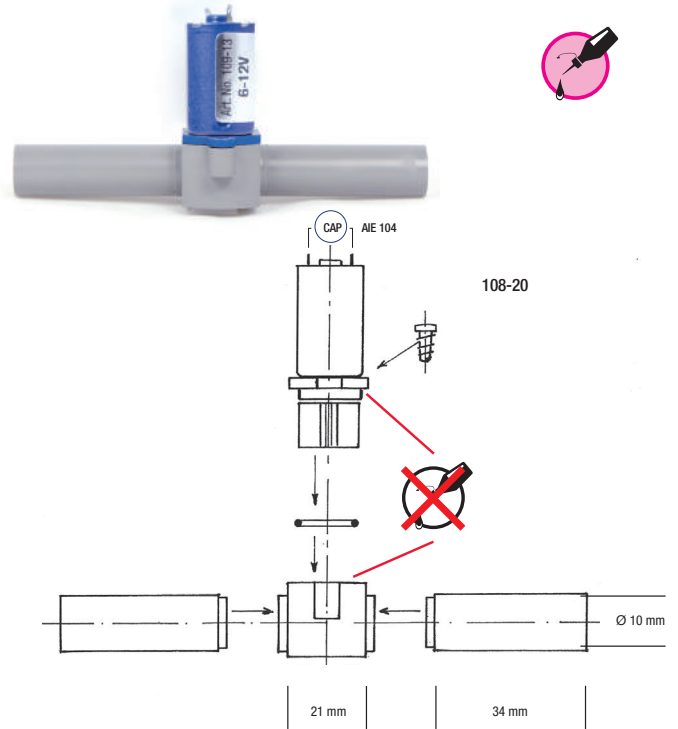

# Jet Nozzle Extension Set

Straalbus verlengset - Düsenverlängerung Satz - Kit d'extension de tube à jet

108-36 > 45 Jet nozzle extension optional set

Code	For bow thruster	Diameter outside	Diameter inside	Length	Socket	Content
108-39	108-20	$\varnothing$ 12 mm	$\varnothing$ 10 mm	120 mm		2
108-40	108-01	$\varnothing$ 16 mm	$\varnothing$ 14 mm	200 mm	$\varnothing$ 18 x 16 x 40 mm	2
108-41	108-02	$\varnothing$ 16 mm	$\varnothing$ 19 mm	200 mm	$\varnothing$ 19 x 21 x 40 mm	2
108-42	108-03	$\varnothing$ 22 mm	$\varnothing$ 19 mm	200 mm		2
108-43	108-04	$\varnothing$ 25 mm	$\varnothing$ 22 mm	200 mm	$\varnothing$ 28 x 25 x 40 mm	2
108-44	108-05	$\varnothing$ 28 mm	$\varnothing$ 25 mm	200 mm		2
108-45	108-30	$\varnothing$ 33 mm	$\varnothing$ 30 mm	200 mm		2



# Bow Thrusters

Boegschroeven - Querstrahlruder - Propulseurs d'étrave

## 108-30

108-30

Bow thruster with 2 brass 3 blade propellers.  
 A G-ring ensures water tightness.  
 The gears are water-lubricated.  
 Diameter of the jet nozzle:  $\varnothing$  30 x 33mm.  
 Blue RM-410 7.2 Volt - 11 Amp max. (See page 16: art. 109-41)  
 Length of the motor housing: 48 mm.  
 Total length: 138 mm.  
 Total height: 85 mm.  
 Weight 150 gr.

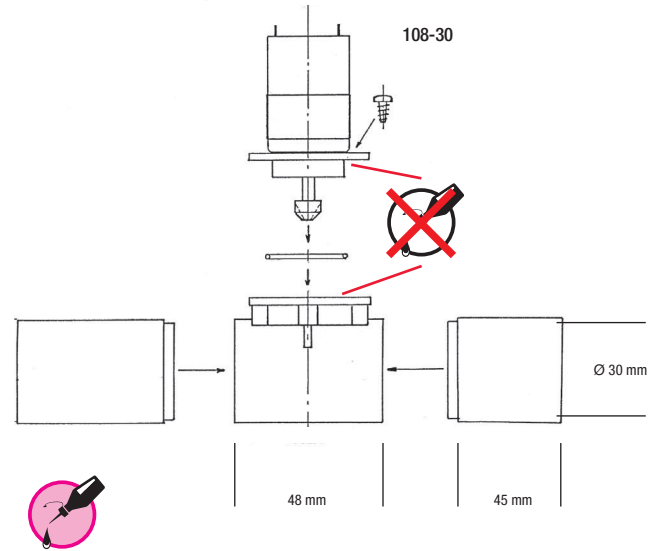

Optional motors  
 6V code 109-40  
 12V code 109-43  
 see page 16

Optional 5 blade propeller  
 108-38 see below



108-33



108-33 - 3 blade

METRIC shaft connection  
 side screw M3 x 4mm included

Code	D mm	D inch	R/L	shaft hole	pitch mm	Hub $\varnothing$ x Length	RPM max.
108-33	29	1.14	R	$\varnothing$ 4 mm	26,7	12 x 9mm	14500

108-38



108-38

METRIC shaft connection  
 side screw M3 x 4mm included

Optional 5 blade propeller

Code	D mm	D inch	R/L	shaft hole	pitch mm	Hub $\varnothing$ x Length	RPM max.
108-38	29	1.14	R	$\varnothing$ 4 mm	26,7	12 x 9mm	14500

# Rudders

Roeren - Ruder - Gouvernails

Code

- Balance rudders for electric boats and scale models with realistic blade shapes.**
- 107-00: Blade size 25x42 mm (ABS), shaft  $\varnothing$  3 mm brass, nylon tiller arm and ABS tube.
  - 107-01: The same construction, blade size > 30x49 mm.
  - 107-02: For the bigger scale Model  $\varnothing$  4 mm stainless steel shaft and hard brass bearings. Tiller arm with a non slip connection (26 splines). Blade size: 36x60 mm.
  - 107-04: Slanting rudder for the competition boats, to make sharp corners. Shaft 5mm SS, tube > brass and hard brass bearings.
  - 107-05: Rudder construction for general use.
  - 107-06: Rudder construction for general use.
  
  - Balance rudders for speedboats up to 3,5 cc.**
  - 107-30: Blade 22x40mm,
  - 107-31: 35x47mm SS Shaft and hard brass bearings
  - 107-38/39/40/41/43: Nylon Tiller arms with 26 splines and  $\varnothing$  2-3-4-5-6 mm hole. See page 23.
  - 107-42: Nylon Tiller arm for rudder with  $\varnothing$  3 mm shaft. See page 23.

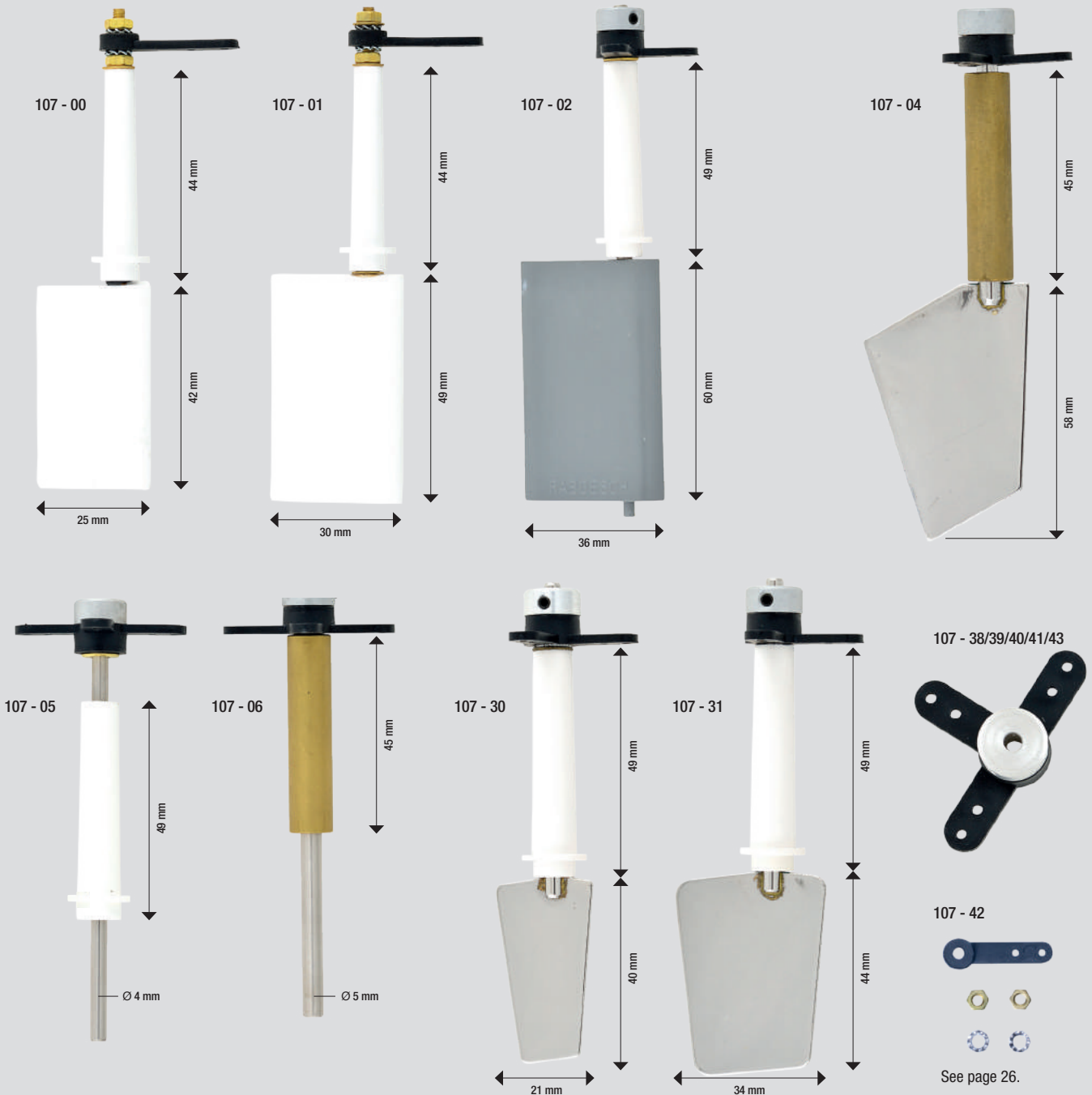

See page 26.

# Propeller Shafts

Schroefassen - Schiffswellen - Arbres d'hélices

Code	Max RPM In the water	Tube diameter C	Bearing front	Bearing rear	Tube length A	Shaft length B	D	Thread x Length E	G	
300-00	12000	Ø 5x6	mm	Bronze	Hard Brass	140 mm	180 mm	Ø 2 mm	M2 x 10 mm	
300-01	7000	Ø 5x7	mm	Hard Brass	Hard Brass	220 mm	270 mm	Ø 4 mm	M4 x 16 mm	
300-03	10000	Ø 4,5x8	mm	Bronze	Bronze	220 mm	290 mm	Ø 4 mm	M4 x 18 mm	Ø 10,20 mm
300-04	9000	Ø 5x6	mm	Bronze	Hard Brass	228 mm	270 mm	Ø 3 mm	M3 x 11 mm	Ø 08,70 mm
300-11	16000	Ø 8x10	mm	Ball Bearing	Bronze	370 mm	450 mm	Ø 6 mm	M5 x 25 mm	Ø 15,70 mm

These RABOESCH high quality propeller shafts have a large range of application. For simple electric boats which are made from ABS, wood, please use 300-00/04. 300-01-03 have strong ABS tubes which makes gluing to your scale model very simple. The other propeller shafts have brass tubes. 300-11 has an extra strong shaft and tube. All the RABOESCH propeller shafts can be shortened very easily. All shafts are made of STAINLESS STEEL.

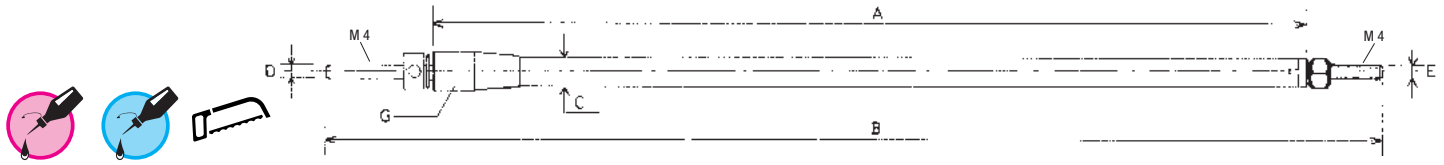

Code	A	B	C	D	E	G	Max RPM
301-00	240 mm	290 mm	Ø 8 mm	Ø 4 mm	M4	Ø 10,40 mm	15.000
301-01	240 mm	290 mm	Ø 6 mm	Ø 4 mm	M4	Ø 10,40 mm	15.000

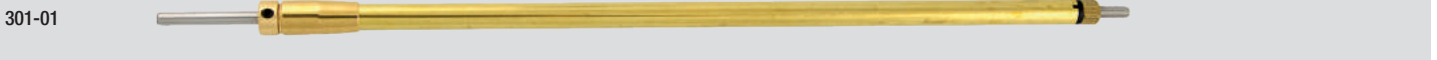

Totally maintenance-free shaft and watertight propeller shafts. Bearing House (G) has a bronze bearing and a G/O-ring. Sleeves: Brass. Shafts: S.S. Precision nut: (F). Rear Bearing: Delrin. Maximum RPM: 15.000 in the water. These shafts are suitable for sailing ships with auxiliary motor and classic small steam boats.

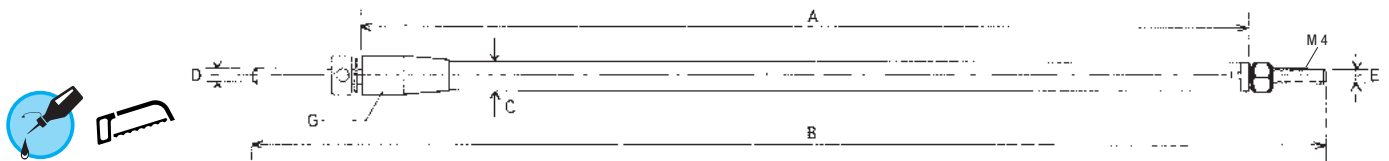

Code	A	B	C	D	E	G	Max RPM
301-22	150 mm	186 mm	Ø 6 mm	Ø 4 mm	M4 x16 mm	Ø 10,50 mm	15.000
301-23	175 mm	211 mm	Ø 6 mm	Ø 4 mm	M4 x16 mm	Ø 10,50 mm	15.000
301-24	200 mm	236 mm	Ø 6 mm	Ø 4 mm	M4 x16 mm	Ø 10,50 mm	15.000
301-25	225 mm	261 mm	Ø 6 mm	Ø 4 mm	M4 x16 mm	Ø 10,50 mm	15.000
301-26	254 mm	290 mm	Ø 6 mm	Ø 4 mm	M4 x16 mm	Ø 10,50 mm	15.000



Totally maintenance-free shaft and watertight propeller shafts. Bearing House (G) has a bronze bearing and a G/O-ring. Sleeves: Brass. Shafts: S.S. Precision nut: (F). Rear Bearing: Delrin. Maximum RPM: 15.000 in the water. These shafts are suitable for sailing ships with auxiliary motor and classic small steam boats.

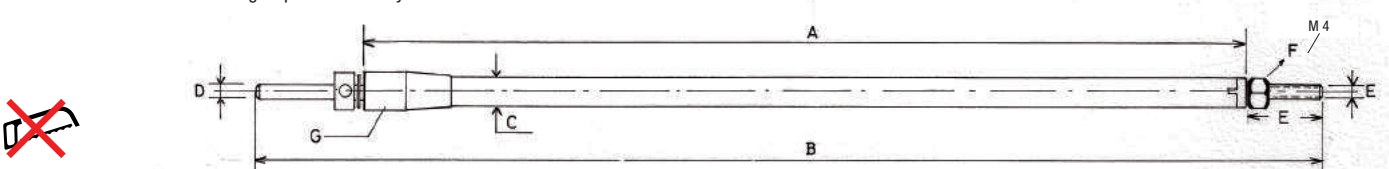



# Propeller Shafts

Schroefassen - Schiffswellen - Arbres d'hélices

Code	A	B	C	D	E	G	RPM
301-07	240 mm	290 mm	Ø 8 mm	Ø 4 mm	M4	Ø 15,80 mm	15.000
301-08	240 mm	290 mm	Ø 8 mm	Ø 5 mm	M5	Ø 15,80 mm	15.000
301-09	395 mm	450 mm	Ø 8 mm	Ø 4 mm	M4	Ø 15,80 mm	15.000
301-10	395 mm	450 mm	Ø 10 mm	Ø 5 mm	M5	Ø 15,80 mm	15.000

301-07 > 10



Totally maintenance-free shaft and watertight propeller shafts. Bearing House (G) has a **ball bearing** and a G-ring. Sleeves: Brass. Shafts: S.S. Precision nut: (F). Rear Bearing: Delrin. Maximum RPM: 15.000 in the water.

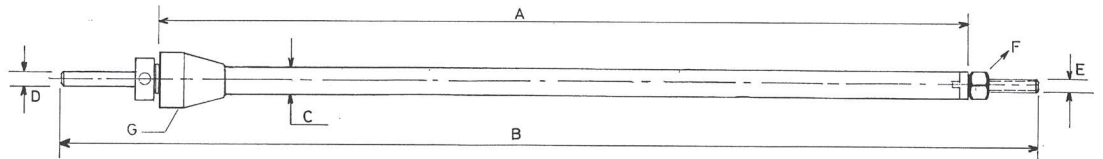

Code	A	B	C	D	E	G	H	S
301-11	140 mm	230 mm	Ø 6 mm	Ø 2 mm	M2		P-Bracket 301-14	Ø 2 mm O ring
301-12	148 mm	270 mm	Ø 6 mm	Ø 3 mm	M3	Ø 08,70 mm	P-Bracket 301-15	Ø 3 mm O ring
301-13	153 mm	330 mm	Ø 8 mm	Ø 4 mm	M4	Ø 10,40 mm	P-Bracket 301-16	Ø 4 mm G ring
301-18	163 mm	390 mm	Ø 8 mm	Ø 5 mm	M5	Ø 10,40 mm	P-Bracket 301-17	Ø 5 mm O ring

301-11 > 18



Totally maintenance-free shaft and watertight propeller shafts. Bearing House (G) has a bronze bearing and a G/O-ring. Sleeves: Brass. Shafts: S.S. Precision nut: (F). Rear Bearing: Delrin. Maximum RPM: 15.000 in the water.

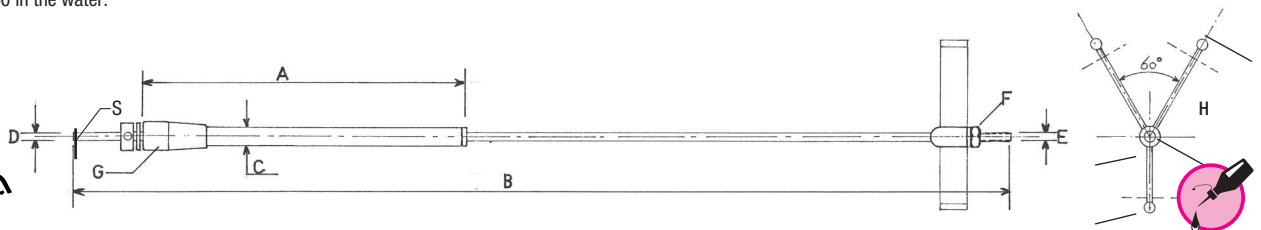

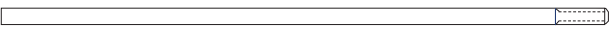
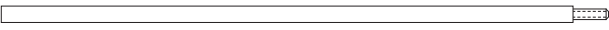
Code	Length	Diam	Thread x Length	Stainless steel METRIC shaft
350-59	230 mm	Ø 2 mm	M2 x 10 mm	
350-60	270 mm	Ø 3 mm	M3 x 11 mm	
350-61	290 mm	Ø 4 mm	M3 x 11 mm	
350-62	290 mm	Ø 4 mm	M4 x 18 mm	
350-63	290 mm	Ø 5 mm	M4 x 18 mm	
350-64	450 mm	Ø 5 mm	M5 x 25 mm	
350-65	450 mm	Ø 6 mm	M4 x 25 mm	
350-66	450 mm	Ø 6 mm	M5 x 25 mm	
350-69	450 mm	Ø 4 mm	M4 x 23 mm	
350-70	290 mm	Ø 5 mm	M5 x 18 mm	

These RABOESCH high quality propeller shafts have a large range of application.

350-59 > 70

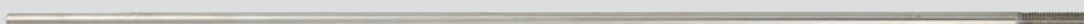

# Couplings

Koppelingen - Kupplungen - Cardans

106-40 + 2x insert 106 serie



## 106-40 Cardan coupling

Code	length	description
106-40	32 mm	Nylon Coupling



## 106-02 > 13 Insert

Code	Shaft or Engine Connection
106-02	Ø 2,0 mm
106-03	Ø 2,3 mm
106-13	Ø 2,5 mm
106-04	Ø 3,0 mm
106-05	Ø 4,0 mm
106-07	Ø 5,0 mm
106-08	Ø 6,0 mm
106-09	Ø 1/8 inch (3,18)
106-10	Ø 3/32 inch (2,38)
106-11	Ø 3/16 inch (4,76)
106-12	Ø 1/4 inch (6,35)



## 106-20 > 25 Insert

Code	Shaft or Engine Connection
106-20	M4
106-21	M5
106-22	M6
106-23	1/4 inch UNF
106-24	1/4 inch BSF
106-25	3/16 inch UNF



## 106-30 Double insert

Code	D mm/inch	Shaft or Engine Connection
106-30		Double insert



101 + 102 + 2x insert 106 serie



## 101 / 102 male/female Coupling

Code	length	description
101-01	male 29 mm	Nylon Coupling
102-01	female 24 mm	Nylon Coupling



## 106-54 > 58 Rigid Couplings 2x Metric lock screw included

Code	Mounting hole	Length	Outer dimensions
106-54	Ø 2,0 mm	15 mm	Ø 10,0 mm
106-55	Ø 3,0 mm	20 mm	Ø 11,0 mm
106-56	Ø 4,0 mm	25 mm	Ø 12,0 mm
106-57	Ø 5,0 mm	25 mm	Ø 13,0 mm
106-58	Ø 6,0 mm	30 mm	Ø 13,0 mm



## 106-59 > 67 Rigid Couplings for different shaft connections 2x Metric lock screw included

Code	Mounting hole	Length	Outer dimensions
106-59	Ø 3,0 > 2,3 mm	20 mm	Ø 11,0 mm
106-60	Ø 4,0 > 2,3 mm	25 mm	Ø 12,0 mm
106-61	Ø 3,2 > 3,0 mm	20 mm	Ø 11,0 mm
106-62	Ø 4,0 > 3,0 mm	25 mm	Ø 12,0 mm
106-63	Ø 4,0 > 3,2 mm	25 mm	Ø 12,0 mm
106-64	Ø 5,0 > 4,0 mm	25 mm	Ø 13,0 mm
106-65	Ø 6,0 > 4,0 mm	30 mm	Ø 13,0 mm
106-66	Ø 5,0 > 3,2 mm	25 mm	Ø 13,0 mm
106-67	Ø 6,0 > 5,0 mm	30 mm	Ø 13,0 mm



# Spare Parts

Reserve onderdelen - Ersatzteile - Pièces de rechange



108-07		Loose jet nozzle	
Code	description		
108-07	for bow thruster 108-01	Ø 14 x 16 mm	

108-23		Loose jet nozzle	
Code	description		
108-23	for bow thruster 108-20	Ø 10 x 12 mm	

108-34		Gear set	
Code	description		
108-34	for bow thruster 108-30		

108-38		optional 5 blade for 108-30			
Code	D mm	D inch	R/L	shaft mm	pitch mm
108-38	29		R	Ø 4	26,7

108-08		Loose jet nozzle	
Code	description		
108-08	for bow thruster 108-02	Ø 16 x 19 mm	

108-32		Loose jet nozzle	
Code	description		
108-32	for bow thruster 108-30	Ø 30 x 33 mm	

108-35		Paddle set	
Code	description		
108-35	for bow thruster 108-01 > 03		

354-01 > 02		Stainless steel bolts	
Code	description	D mm	
354-01	stainless steel bolts (4x)	M2 x 6mm	
354-02	stainless steel bolts (4x)	M2,5 x 8mm	

108-09		Loose jet nozzle	
Code	description		
108-09	for bow thruster 108-03	Ø 19 x 22 mm	

108-06		Repair set	
Code	description		
108-06	for bow thruster 108-01 > 05		

108-37		Paddle	
Code	description		
108-37	for bow thruster 108-20		

355-01		Parker	
Code	description	D mm	
355-01	parker (4x)	3 x 6mm	

108-10		Loose jet nozzle	
Code	description		
108-10	for bow thruster 108-04	Ø 22 x 25 mm	

108-21		Repair set	
Code	description		
108-21	for bow thruster 108-20		

108-36		Paddle set	
Code	description		
108-36	for bow thruster 108-04 > 05		

359-01 > 05		G-Rings	
Code	description	Dimension inside x outside x height	
359-01	G-rings (2x)	Ø 3 x Ø 6 x 3,0mm	
359-02	G-rings (2x)	Ø 4 x Ø 8 x 2,2mm	
359-03	G-rings (2x)	Ø 5 x Ø 9 x 2,2mm	
359-04	G-rings (2x)	Ø 5 x Ø 10 x 2,2mm	
359-05	G-rings (2x)	Ø 6 x Ø 10 x 2,2mm	

108-11		Loose jet nozzle	
Code	description		
108-11	for bow thruster 108-05	Ø 25 x 28 mm	

108-31		Repair set	
Code	description		
108-31	for bow thruster 108-30		

108-33		Brass propeller for bow thruster 108-30			
Code	D mm	D inch	R/L	shaft mm	pitch mm
108-33	29		R	Ø 4	26,7

104-46		Rubber O-Rings	
Code	description	Dimension inside x outside x height	
104-41	for shaft 2mm (2x)	Ø 2 x Ø 5 x 1,5mm	
104-42	for shaft 3mm (2x)	Ø 3 x Ø 6 x 1,5mm	
104-43	for shaft 4mm (2x)	Ø 4 x Ø 7 x 1,5mm	
104-44	for shaft 4mm (2x)	Ø 4 x Ø 8 x 2,0mm	
104-45	for shaft 5mm (2x)	Ø 5 x Ø 8 x 1,5mm	
104-46	for shaft 5mm (2x)	Ø 5 x Ø 9 x 2,0mm	

# Spare Parts

Reserve onderdelen - Ersatzteile - Pièces de rechange

100-01		Hose nipple
Code	description	D mm
100-01	hose nipple for hull	4 mm



301-14 > 17		P-Bracket
Code	description	D mm
301-14	single p-bracket with brass bearing	Ø 2 mm
301-15	single p-bracket with brass bearing	Ø 3 mm
301-16	single p-bracket with brass bearing	Ø 4 mm
301-17	single p-bracket with brass bearing	Ø 5 mm

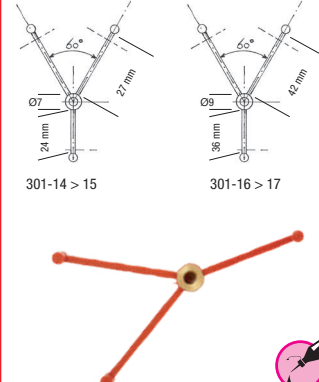

356-01		Brass nipple
Code	description	D mm
356-01	brass nipple (4x)	M4 x 17 x Ø 6



360-01 > 10		Delrin Bearings	
Code	inside x outside x height	for shaft	Content
360-01	Ø 4 x Ø 5 x 8mm	301-01/22 > 26	2
360-07	Ø 4 x Ø 7 x 10mm	301-00/07/09/13	2
360-08	Ø 5 x Ø 7 x 10mm	301-08	2
360-10	Ø 5 x Ø 8 x 10mm	301-10	2



351-01 > 04		Brass nuts plus washer
Code	description	D mm
351-01	brass nuts plus washers (4x)	M2
351-02	brass nuts plus washers (4x)	M3
351-03	brass nuts plus washers (4x)	M4
351-04	brass nuts plus washers (4x)	M5



358-00 > 04		Bronze bearings
Code	description	Dimension inside x outside x height
358-00	bronze bearings (2x)	Ø 2 x Ø 5 x 3mm
358-01	bronze bearings (2x)	Ø 3 x Ø 6 x 6mm
358-02	bronze bearings (2x)	Ø 4 x Ø 8 x 8mm
358-03	bronze bearings (2x)	Ø 5 x Ø 8 x 8mm
358-04	bronze bearings (2x)	Ø 6 x Ø 10 x 12mm



106 / 352		Hexagon key and setscrews
Code	description	D mm
106-71	hexagon key 1,5 mm for M3	
106-72	hexagon key 1,27 mm for M2,5	
352-01	hexagon key + 4x set screw	M3 x 4 mm
352-02	hexagon key + 4x set screw	M4 x 4 mm
352-03	hexagon key + 4x set screw	M5 x 4 mm
352-00	hexagon key + 4x set screw	M2,5 x 3 mm



107-39 > 42		Tiller arms	
Code	description	D mm	Content
107-38	Nylon Tiller arm	2 mm	1
107-39	Nylon Tiller arm	3 mm	1
107-40	Nylon Tiller arm	4 mm	1
107-41	Nylon Tiller arm	5 mm	1
107-42	Nylon Tiller arms	3 mm	2
107-43	Nylon Tiller arm	6 mm	1



353-01 > 04		Stainless steel
Code	description	D mm
353-01	stainless steel nuts plus washers (4x)	M2
353-02	stainless steel nuts plus washers (4x)	M3
353-03	stainless steel nuts plus washers (4x)	M4
353-04	stainless steel nuts plus washers (4x)	M5



357-01 > 03		Ball bearings
Code	description	Dimension inside x outside x height
357-01	ball bearings (2x)	Ø 4 x Ø 13 x 5mm
357-02	ball bearings (2x)	Ø 5 x Ø 13 x 4mm
357-03	ball bearings (2x)	Ø 6 x Ø 13 x 5mm



300		High Temperature Shaft Grease
Code	description	Weight
300-70	High Temperature Shaft Grease	500 gram
300-71	High Temperature Shaft Grease	60 gram



104-03 > 09		Rubber vibration absorbers			
Code	description	Ø x H mm	thread	° shore	content
104-03	Vibr. Absorbers	Ø 10 x 10 mm	M4 x 10	70°	4x
104-04	Vibr. Absorbers	Ø 15 x 8 mm	M4 x 10	70°	4x
104-05	Vibr. Absorbers	Ø 15 x 12 mm	M4 x 10	70°	4x
104-09	Vibr. Absorbers	Ø 20 x 15mm	M6 x 18	70°	4x



- GB** Our plastic products are produced from the polymer ASA (Acrylonitrile - Styrene - Acrylester) and Styrene. They can simply be glued by using hard plastic PVC-gluе or with two component glue. On this page we give you glue advice.
- NL** Onze kunststof producten zijn vervaardigd van het polymeer: ASA (Acrylonitrile - Styreen - Acrylester) en Styreen. Ze kunnen eenvoudig worden verlijmd met hardplastіc PVC-lijm of 2-componentenlijm. Op deze pagina geven wij u lijmadvies.
- DE** Unsere Kunststoffprodukte sind aus Polymer ASA (Acrylonitril - Styrol - Acrylester) hergestellt und aus Styrol und können einfach mit dem Hartplastіc-PVC-Klebstoff oder mit einem Zwei-Komponenten-Klebstoff verklebt werden. Auf dieser Seite geben wir Ihnen Kleber Beratung.
- FR** Nos produits en plastique sont réalisés en polymère ASA (acrylonitrile styrène acrylate) et en styrène. Ils sont faciles à coller avec une colle pour PVC rigide ou une colle à deux composants. Sur cette page, nous vous donnons des conseils de colle.



### Plastic glue for ASA, Styrene, PVC, Polycarbonate and PVC foam



**UHU plast special UH45880**  
[www.uhu-profishop.com](http://www.uhu-profishop.com)



**BISON Model Plastic**  
[www.bison.nl](http://www.bison.nl)  
[www.bison.be](http://www.bison.be)



**RUDERER L530**  
[www.ruderer.de](http://www.ruderer.de)



**Deluxe Rokat Plastic Glue AD62**  
[www.deluxematerials.com](http://www.deluxematerials.com)



**Faller Expert 170492**  
**Faller Super Expert 170490**  
[www.faller.de](http://www.faller.de)



### Two component glue and instant adhesive for Evacast, Polyester, Polypropylene, Lexan and Brass



**Pattex Power Epoxy 2 component glue**  
[www.pattex.com](http://www.pattex.com)



**LOCTITE 401 instant adhesive**  
[www.loctite.com](http://www.loctite.com)



### Rubber glue



**BISON Rubber Glue**  
[www.bison.nl](http://www.bison.nl)  
[www.bison.be](http://www.bison.be)



**Pattex Special Rubber Glue**  
[www.pattex.com](http://www.pattex.com)



**Deluxe Rokat Cyano Glue Gel AD69**  
[www.deluxematerials.com](http://www.deluxematerials.com)



This product can be shortened by using a saw

# Plastic profiles & sheets

Kunststof profielen & platen - Kunststoff Profile & Platten - Profilés & feuilles en Plastique



**GB** Raboesch Models BV is also a plastic sheets & profiles manufacturer. Since January 2015 we have been providing these products under a new trading name: MAQUETT. Our high-quality products are used for scale model construction, model building and model railway building. We furthermore also provide our products to the furniture sector, architectural firms, research & development departments and the general industry.

Ask your local model building shop or hobby shop for the MAQUETT catalog or download the catalog via [www.maquett.nl](http://www.maquett.nl). On our website you will also find an up-to-date overview of our products and activities.

**NL** Raboesch Models BV is tevens fabrikant van plastic sheets & profielen. Sinds januari 2015 leveren we deze producten onder de nieuwe handelsnaam MAQUETT. Onze kwalitatief hoge producten worden gebruikt voor schaalmodelbouw, maquettebouw en modelspoorbouw. Daarnaast leveren we aan de meubel branche, architectenbureaus, research & development afdelingen en de industrie.

Vraag uw lokale modelbouwwinkel naar de MAQUETT catalogus of download de catalogus op [www.maquett.nl](http://www.maquett.nl). Op onze website treft u tevens een actueel overzicht aan van onze producten en activiteiten.

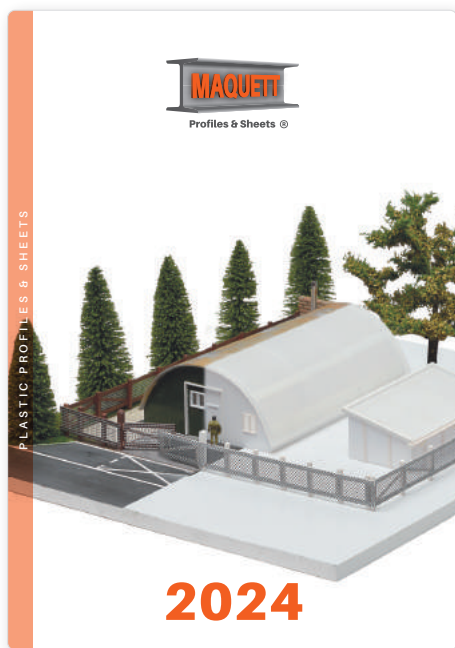

**DE** Raboesch Models BV ist auch Hersteller von Kunststoffplatten und Profilen. Ab Januar 2015 liefern wir dies Produkte unter dem neuen Handelsnamen MAQUETT. Unsere qualitativ hochwertigen Produkte werden für maßstabgerechten Modellbau, Maquettenbau und den Bau von Modelleisenbahnen eingesetzt. Darüber hinaus beliefern wir die Möbelindustrie, Architekturbüros, sowie die Forschungs- und Entwicklungsabteilungen und die Industrie.

Fragen Sie in Ihrem Modellbauladen vor Ort nach dem MAQUETT Katalog oder laden Sie den Katalog auf [www.maquett.nl](http://www.maquett.nl) herunter. Auf unserer Website finden Sie ebenfalls eine aktuelle Übersicht unserer Produkte und Aktivitäten

**FR** Raboesch Models BV est aussi un fabricant de feuilles de plastique et de profilés. A partir du mois de Janvier 2015, nous fournissons ces produits sous le nouveau nom commercial de MAQUETT. Nos produits de haute qualité sont utilisés pour la construction de maquettes, la construction de modèles et la construction dans le cadre du modélisme ferroviaire. Nous livrons également à l'industrie du meuble, aux cabinets d'architectes, aux départements de recherche et développement et à l'industrie.

Demandez à votre magasin de construction de modèles local le catalogue MAQUETT ou téléchargez le catalogue sur [www.maquett.nl](http://www.maquett.nl). Sur notre site web, vous trouverez également un aperçu actuel de nos produits ainsi que de nos activités.

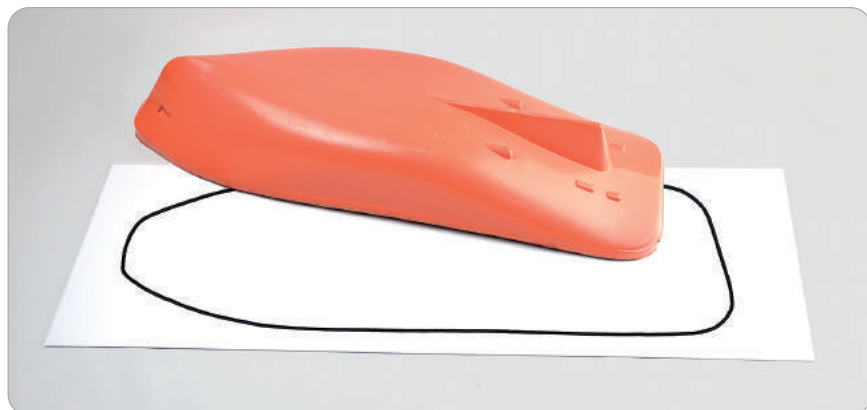

**X-LARGE**  
328x997 mm / 12,9x39,3 inch



part. nr.	color	mm	content
<b>Styrene</b>			
701-04	White	1,00	1
701-05	White	1,50	1
701-06	White	2,00	1
<b>PVC foam</b>			
705-01	White	2,00	1
705-02	White	3,00	1

### Styrene

### PVC foam





hobby products

[www.raboeschmodels.com](http://www.raboeschmodels.com)

Dealer

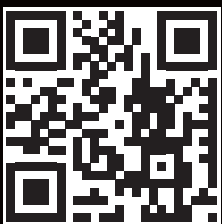

Like us on facebook  
[facebook.com/raboeschmodels](https://facebook.com/raboeschmodels)

Made in the Netherlands



Raboesch Models BV • Schepenveld 18 • NL-3891 ZK Zeewolde cvzThe Netherlands